

445HD IP Phone – Generic SIP

Version 3.4.6

Table of Contents

Notice	1
Trademarks	1
WEEE EU Directive.....	1
Customer Support	1
Stay in the Loop with AudioCodes	1
Abbreviations and Terminology	1
Documentation Feedback.....	1
Related Documentation.....	2
1 Introducing the 445HD IP Phone	3
1.1 445HD IP Phone with Wi-Fi.....	3
1.2 About AudioCodes' Series of High Definition IP Phones.....	3
1.3 Cutting Edge Voice Quality & HD VoIP	3
2 Setting up the Phone.....	4
2.1 Unpacking	4
2.2 Device Description.....	5
2.2.1 Front View.....	5
2.2.2 Rear View	7
2.3 Cabling	8
2.4 Mounting the Phone.....	9
2.4.1 Desktop Mounting.....	9
2.4.1.1 Routing the Handset Cable	9
2.4.2 Wall Mounting.....	10
3 Getting Started	11
3.1 Getting Acquainted with the Phone's Screen	11
3.2 Softkeys.....	12
3.3 Navigating the Phone Menu	13
3.4 Switching between Letters and Numbers.....	15
3.5 Switching to Symbols.....	15
4 Configuring a Line	17
4.1 Displayed Messages.....	17
4.2 Connecting to Wi-Fi	18
5 Using the Phone's Automatic Lock Feature.....	20
5.1 Enabling the Locking Feature	20
5.2 Unlocking a Locked Phone	21
5.3 Manually Changing the Lock Code	22

6	Customizing Your Phone	23
6.1	Changing the Screen Language	23
6.2	Selecting Ring Tone	24
6.3	Enabling Call Waiting	25
6.4	Managing Simultaneous Incoming Calls	26
6.5	Configuring Call Forwarding.....	27
6.6	Configuring Time and Date Settings	29
6.6.1	Making Sure the NTP Server is Enabled	29
6.7	Configuring Screen Brightness	31
6.8	Configuring a Default Audio Device.....	32
6.9	Adjusting Volume	33
6.9.1	Adjusting Ring Volume.....	33
6.9.2	Adjusting Tones Volume	33
6.9.3	Adjusting Handset Volume.....	34
6.9.4	Adjusting Speaker Volume	34
6.9.5	Adjusting Headset Volume.....	34
6.10	Managing your Personal Directory.....	35
6.10.1	Adding a Contact to the Personal Directory.....	35
6.10.2	Editing Contact Information.....	36
6.10.3	Deleting a Contact from the Personal Directory	37
6.10.4	Searching for a Contact in the Personal Directory.....	38
6.11	Programmable Softkeys (PSKs)	39
6.11.1	Customized UI Experience.....	40
6.12	Configuring a Function/Programmable Key as a Speed Dial.....	41
6.12.1	Configuring a Programmable Key for Speed Dialing via Calling Line of Choice	42
6.12.2	Configuring Pause Dialing for a Speed Dial to an Ext. behind an IVR.....	42
6.12.3	Configuring a Speed Dial Key through the Personal Directory	42
6.12.4	Configuring a Speed Dial Key in the Sidecar Fields	43
6.12.5	Editing a Speed Dial	44
6.12.6	Deleting a Speed Dial	44
6.13	Configuring a Function/Programmable Key as a Key Event.....	45
6.14	Configuring a Function/Programmable Key for Direct Voice Dialing	46
6.15	Configuring a Function/Programmable Key for Paging	48
6.16	Deleting a Function/Programmable Key.....	49
7	Performing Basic Operations	50
7.1	Using Audio Devices	50
7.2	Managing Calls	51
7.2.1	Dialing.....	52
7.2.2	Redialing	53
7.2.3	Dialing a Missed Call	54

7.3	Answering Calls	55
7.4	Rejecting Incoming Calls	56
7.5	Silencing Incoming Calls.....	56
7.6	Making a New Call Even Though a Call is Coming in	56
7.7	Ending an Established Call	56
7.8	Viewing the Call Log.....	57
7.9	Using Multiple Lines	59
7.9.1	Choosing a Line.....	59
7.9.2	Making a Call on a Line	59
7.9.3	Making Two Calls on a Line	59
7.9.4	Making Multiple Line Calls	60
7.9.5	Toggling Between Multiple-Line Calls.....	60
7.9.6	Toggling Between Calls on the Same Line.....	61
7.9.7	Ending Calls	61
7.10	Paging a Group	61
7.10.1	Receiving an Incoming Paging Call.....	61
7.10.1.1	If Paged when in a Regular Call and Barge-in is Disabled	62
7.10.1.2	If Paged when in a Regular Call and Barge-in is Enabled	63
8	Performing Advanced Operations.....	64
8.1	Answering Waiting Calls	64
8.2	Placing Calls On Hold	66
8.3	Calling a Contact Listed in the Directory.....	66
8.4	Enabling Auto Redial.....	66
8.5	Handling Multiple Incoming Calls.....	67
8.6	Using a Speed Dial to Call a Contact	68
8.7	Accessing Speed Dials when in a Call.....	69
8.8	Transferring Calls.....	70
8.8.1	Performing a Blind Transfer	70
8.8.2	Performing a Consultative Transfer	71
8.8.3	Transferring a Call to a Remote Party on Hold	72
8.8.4	Merging Calls into a Conference Call	73
8.8.5	Merging a Call with a Call on Hold	74
8.8.6	Leaving a 3-Way Conference You Set up without Disconnecting the Others.....	74
8.9	Activating Do Not Disturb	75
8.10	Retrieving Voice Mail Messages.....	77
8.11	Parking a Call	78
8.12	BLF Call Pickup.....	79
8.13	Managing a Conference.....	79
8.14	Muting the Microphone.....	80
8.15	Paging	81

8.15.1	Barge-in.....	81
8.15.2	Performing a Paging Call	81
8.15.3	Receiving an Incoming Paging Call.....	82
8.16	Configuring Bluetooth on the Phone	84
9	Troubleshooting.....	86
A	Specific Third-Party Features	87
A.1	Ribbon Communications Genband SLA	87
A.1.1	Configuring Shared Line Appearance.....	87
A.1.2	Configuring a Call Pickup Group	87
A.1.3	Configuring BLFs	87
A.2	BroadSoft	88
A.2.1	Shared Call Appearance	88
A.2.1.1	Demonstrating the SCA Feature's Capabilities.....	89
A.2.2	Monitored Lines Based on BroadSoft's BroadWorks BLF Service.....	92
A.2.3	Using Xsi Interface Services.....	92
A.2.3.1	Call Center List.....	92
A.2.3.2	Contact Synchronization.....	93
A.2.3.3	Call Log Synchronization	93
A.2.4	Configuring the 'Forward No Reply' Timeout as Number of Rings	93
A.2.5	Automatically Receiving an External Line	93
A.2.6	Limiting Configuration of Function Keys as Line Keys.....	93
A.2.7	Viewing VOICEMAIL Indications <i>Per Line</i>	93
A.2.8	Listening in Capability for Call Center Supervisors	94
A.2.9	Recording an Agent's Welcome Greeting	94
A.3	Genesys' Contact Centers	95
A.3.1	Using the BroadSoft ACD	95
A.3.1.1	Setting Unavailability Status	95
A.3.1.2	Setting Availability Status	95
A.3.2	Presence Management.....	96
A.3.3	Logging In.....	96
A.3.4	Logging Out.....	96
A.3.5	Configuring Do Not Disturb (DnD)	96
A.3.6	Configuring Automatic Forwarding.....	96
A.3.7	Listening in Capability for Call Center Supervisors	97
A.3.8	Setting up a Remote Conference.....	97

Notice

Information contained in this document is believed to be accurate and reliable at the time of printing. However, due to ongoing product improvements and revisions, AudioCodes cannot guarantee accuracy of printed material after the Date Published nor can it accept responsibility for errors or omissions. Updates to this document can be downloaded from <https://www.audiocodes.com/library/technical-documents>.

This document is subject to change without notice.

Date Published: December-30-2021

Trademarks

AudioCodes Ltd. All rights reserved. AudioCodes, AC, HD VoIP, HD VoIP Sounds Better, IPmedia, Mediant, MediaPack, What's Inside Matters, OSN, SmartTAP, VMAS, VoIPerfect, VoIPerfectHD, Your Gateway To VoIP, 3GX, VocaNom, AudioCodes One Voice and CloudBond are trademarks or registered trademarks of AudioCodes Limited All other products or trademarks are property of their respective owners. Product specifications are subject to change without notice.

WEEE EU Directive

Pursuant to the WEEE EU Directive, electronic and electrical waste must not be disposed of with unsorted waste. Please contact your local recycling authority for disposal of this product.

Customer Support

Customer technical support and services are provided by AudioCodes or by an authorized AudioCodes Service Partner. For more information on how to buy technical support for AudioCodes products and for contact information, please visit our Web site at <https://www.audiocodes.com/services-support/maintenance-and-support>.

Stay in the Loop with AudioCodes



Abbreviations and Terminology

Each abbreviation, unless widely used, is spelled out in full when first used.

Documentation Feedback

AudioCodes continually strives to produce high quality documentation. If you have any comments (suggestions or errors) regarding this document, please fill out the Documentation Feedback form on our Web site at <http://online.audiocodes.com/documentation-feedback>.

Related Documentation

Document Name
400HD Series IP Phones Release Notes – Generic SIP.
400HD Series IP Phones Administrator’s Manual – Generic SIP.
445HD IP Phone Quick Guide – Generic SIP.

1 Introducing the 445HD IP Phone

AudioCodes' 445HD IP Phone – Generic SIP is based on AudioCodes High Definition voice technology, providing clarity and a rich audio experience in Voice-over-IP (VoIP) calls.

The 445HD IP phone is an advanced high-end business phone with a 4.3" color screen. The 445HD includes an integrated, dedicated LCD sidecar displaying contacts and their presence.

The phone is a 1-line, 2 concurrent calls per line, premium model which includes a large, color, multi-language graphic Liquid Crystal Display (LCD).

The phone is a fully-featured telephone that provides voice communication over an IP network, allowing you to place and receive phone calls, put calls on hold, transfer calls, make conference calls, etc.

AudioCodes IP phones can be offered as part of our of Managed IP Phones solution which defines the phone as an IT-managed entity and delivers unique and complete lifecycle management of end-user desktop devices.

Read this *User's Manual* carefully to learn how to operate the product and take advantage of its rich feature set.

1.1 445HD IP Phone with Wi-Fi

The UC445HDEG-BW and UC445HDEPSG-BW models of the 445HD phone can connect to an Access Point via Wi-Fi. The Wi-Fi interface can be used when the phone is installed in an environment free of LAN/cables, to perform VoIP calls over Wi-Fi. See Section 4.2 for more information.

1.2 About AudioCodes' Series of High Definition IP Phones

AudioCodes Series of High Definition IP Phones offers a new dimension of voice call quality and clarity for the IP Telephony market. This new series of IP Phones further expands AudioCodes' VoIP product offering for the service providers' hosted services, Enterprise IP telephony and Enterprise contact centers markets. As a natural addition to the AudioCodes Mobile Clients, Media Gateway, Media Server & Multi-Service Business Gateway products, the AudioCodes Series of High Definition IP Phones enable Systems Integrators and end-customers to build end-to-end solutions that rely on AudioCodes' technological advantage and proven track record in providing state-of-the-art products. The AudioCodes Series of High Definition IP Phones meet a growing demand for High Definition VoIP solutions in end-user phones and terminals, improving the productivity and efficiency of business communications with new quality standards set by the High Definition voice technology.

1.3 Cutting Edge Voice Quality & HD VoIP

Based on AudioCodes' advanced, robust and field-proven VoIPerfectHD™ software, AudioCodes' IP Phones are designed to utilize wideband coders. The phones feature enhanced proprietary capabilities such as packet loss concealment, high quality wideband acoustic echo canceler, and low-delay adaptive jitter buffers to enrich the HDVoIP experience.

2 Setting up the Phone

2.1 Unpacking

When unpacking, make sure the following items are present and undamaged:

IP Phone / Stand

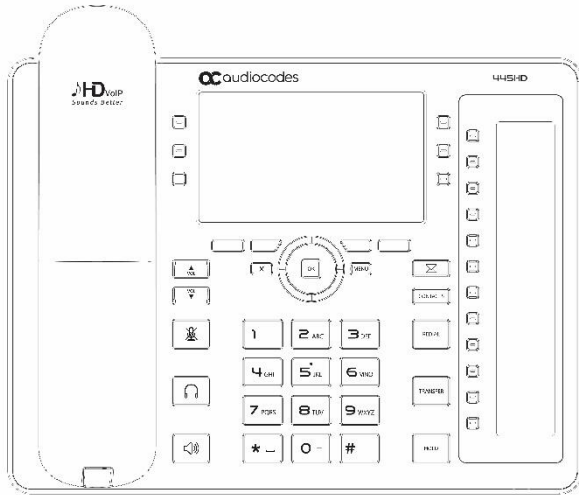

Handset / Cord

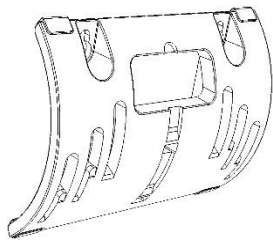

Cat 5e Ethernet Cable

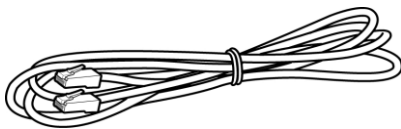

AC Power Adapter (Optional)

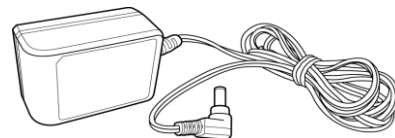

If anything appears to be missing or broken, contact the distributor from whom you purchased the phone for assistance.

2.2 Device Description

Use the graphics below to identify and familiarize yourself with the device's hardware functions.

2.2.1 Front View

The front view of the phone is shown in Figure 2-1 and described in Table 2-1.

Figure 2-1: Front View

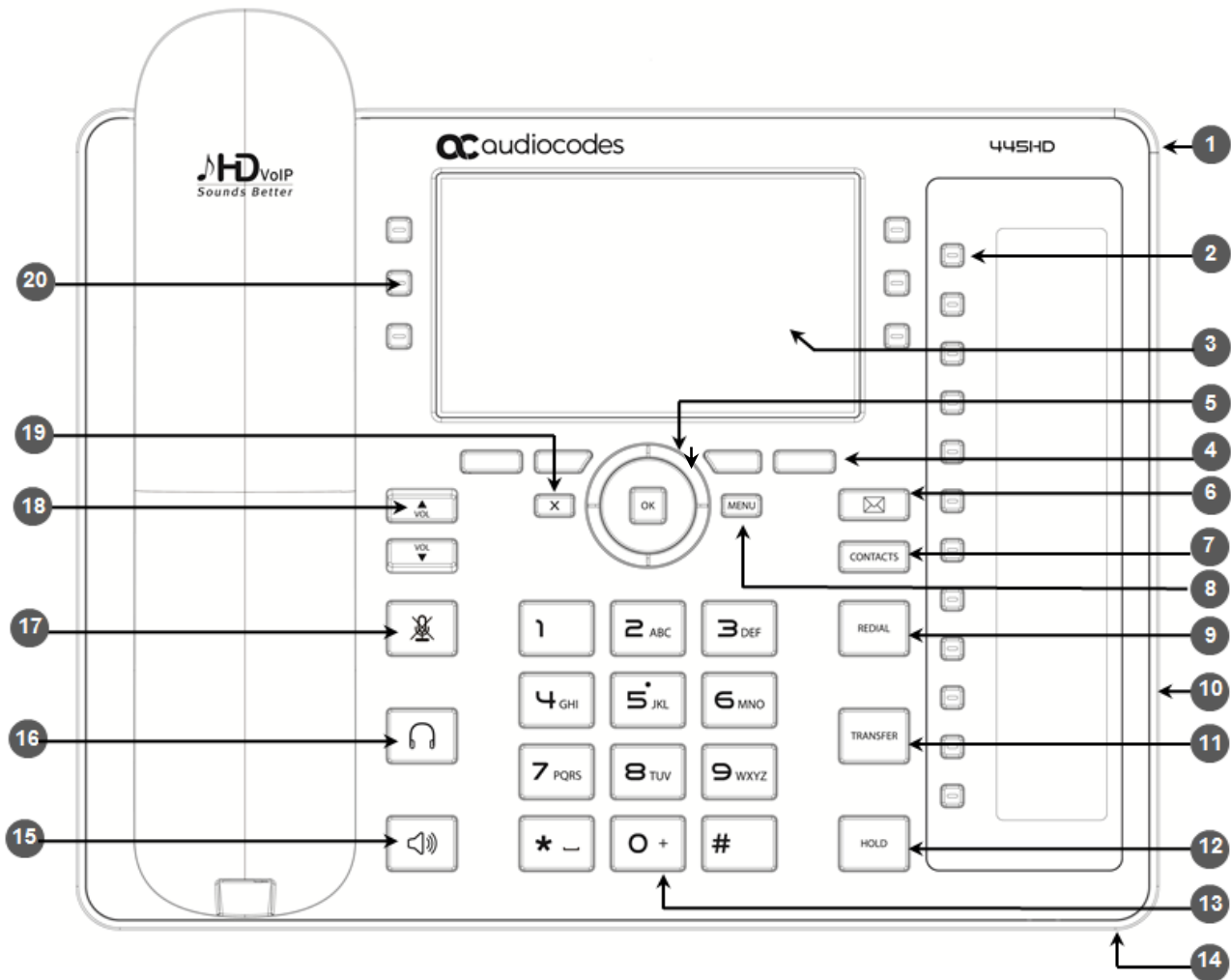

Table 2-1: Font View Description

Item #	Label/Name	Description
1	Ring LED	Indicates phone status: <ul style="list-style-type: none"> ■ Green: Idle state ■ Flashing blue: Incoming call (ringing) Red: Answered call
2	Speed Dial & BLF	Twelve speed dial buttons to quickly call the contact whose name is displayed adjacent to it. You can configure these speed dial buttons with Busy Lamp Field (BLF) functionality. On the 440HD phone, a dedicated electronic screen displays contacts' names. On the 430HD phone, you can attach to a paper strip handwritten contacts' names.
3	Screen	LCD screen which displays calling information.
4	Softkeys	See Section 3.2 for details on the four softkeys and the available functions they offer.
5	Navigation Control / OK	<ul style="list-style-type: none"> ■ Press the button's upper rim to scroll up menus/items in the touch screen. ■ Press the button's lower rim to scroll down. ■ Press the button's left or right rim to move the cursor left or right (when editing a contact number for example). Press OK to select a menu/item/option.
6	Voicemail	Retrieves voicemail messages.
7	CONTACTS	Press to open the Personal Directory. Other directories can be accessed from the Personal Directory.
8	MENU	Accesses menus: <ol style="list-style-type: none"> (1) CALL LOG (2) CALENDAR (3) KEYS CONFIGURATION (4) SETTINGS (5) DEVICE STATUS (6) ADMINISTRATION (7) CONTACTS (8) PAIRING
9	REDIAL	Accesses a list of recently dialed numbers; one can be selected to redial.
10	Kensington lock	Allows locking the device.
11	TRANSFER	Transfers a call.
12	HOLD	Places an active call on hold.
13	Alphanumerical Keypad	Keys for entering numbers, alphabetical letters and symbols (e.g., colons)
14	Microphone	Allows talking and listening. The network administrators can disable it if required.
15	SPEAKER	Activates the phone's speaker, allowing a hands-free conversation.
16	HEADSET	Activates a call using an external headset.
17	MUTE	Mutes a call.
18	▲ VOL	Increases or decreases the volume of the handset, headset, speaker, ring tone and call progress tones.
	▼ VOL	
19	x	Cancel an action, such as dialing a number, after beginning it.
20	---	Programmable keys, located on each side of the screen, to which you can assign functions.

2.2.2 Rear View

The rear view of the phone is shown in the figure below and described in the table below.

Figure 2-2: Rear View

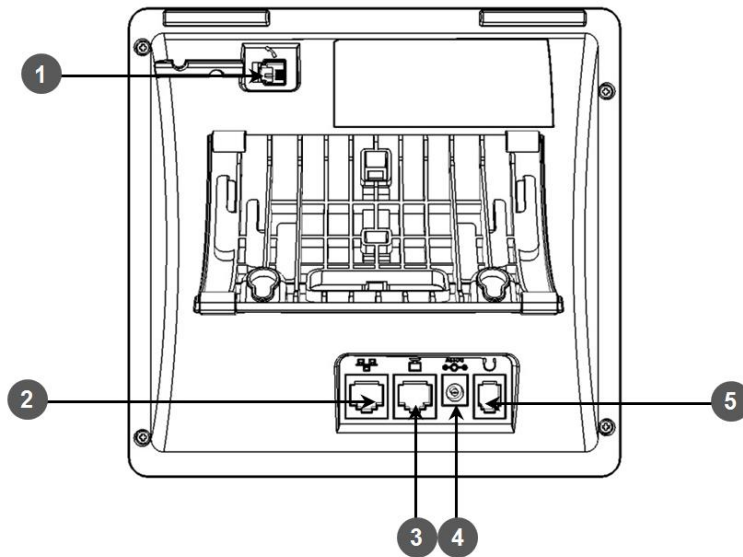







Table 2-2: Rear View Description

#	Label	Description
1		Handset jack, i.e., RJ-9 port, to connect the handset.
2		RJ-45 port to connect to the Ethernet LAN cable for the LAN connection (uplink - 10/100/1000 Mbps). If you are using Power over Ethernet (PoE), power to the phone is supplied from the Ethernet cable (draws power from either a spare line or signal line).
3		RJ-45 port to connect the phone to a PC (10/100/1000 Mbps downlink).
4	 DC12V	12V DC power jack that connects to the AC power adapter.
5		Headset jack, i.e., RJ-9 port that connects to an external headset.

2.3 Cabling

This section covers how to cable your phone. Use the figure and table below as reference.

Figure 2-3: Cabling

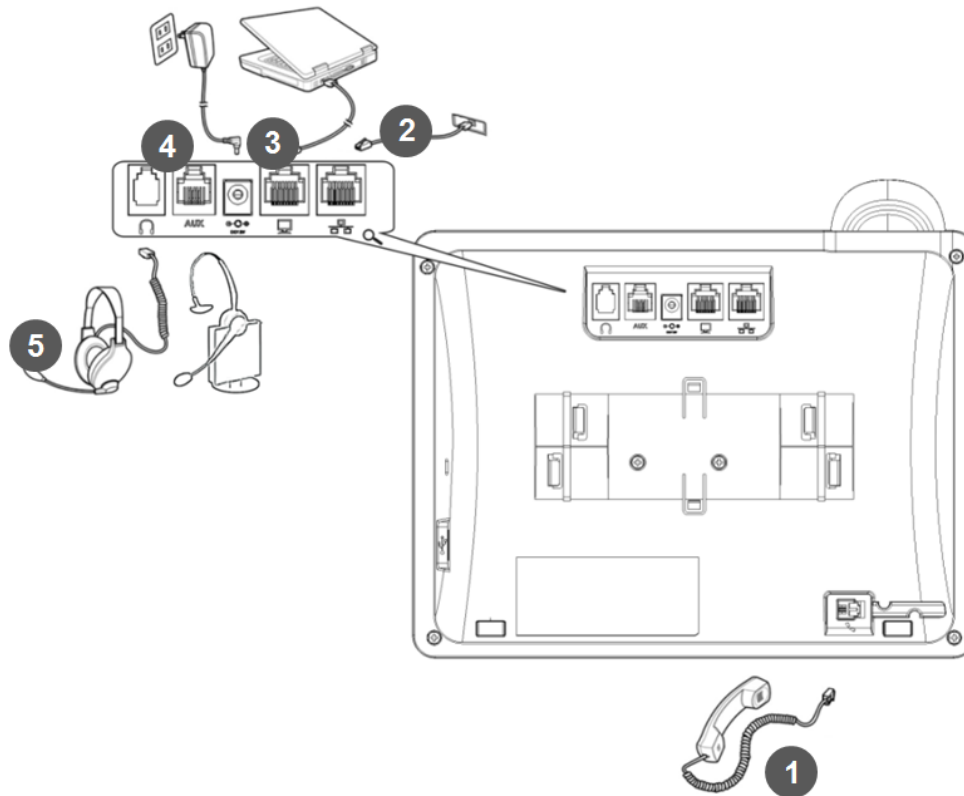

Action	Description
1	Connect the <i>short, straight end of the cord</i> to the handset. Connect the <i>longer, straight end</i> to the jack (RJ-9 port, for the handset) on the phone.
2	Connect the RJ-45 LAN port to your LAN network (LAN port or LAN switch/router), using a CAT 5 / 5e Ethernet cable
3	Connect the RJ-45 PC port to a computer, using a CAT 5 / 5e straight-through Ethernet cable
4	Connect the connector tip of the AC power adapter to the phone's power socket (labelled DC 12V). Connect the two-prong AC adapter directly to the electrical wall outlet. When the phone powers up, all the LEDs momentarily light up
5	Connect the RJ-9 headset jack to a headset (optional)



If the LAN to which the phone is connected supports Power over Ethernet (PoE), no AC adapter is required; the phone receives power from the Ethernet network.



Prior to connecting power, refer to the Compliancy and Regulatory Information at www.audiocodes.com/library.

2.4 Mounting the Phone

The phone can be mounted on a:

- Desk (see Section 2.4.1 below)
- Wall (see Section 2.4.2)

See also <https://www.youtube.com/watch?v=oGe9STB9IFE> to assemble the base stand.

2.4.1 Desktop Mounting

This section describes how to mount the phone on a flat surface like a desk.

To mount the phone on a desk or flat surface:

1. Off-hook the handset (if on-hook) and place the phone upside down, i.e., base-up, on your desktop.
2. On the phone's base, identify outer rails.
3. On the phone's stand, identify outer notches.
4. Invert the stand and align its outer notches with the base's outer rails.
5. Insert the stand's outer notches into the base's outer rails and slide the notches along the rails until the stand click-locks into the base.
6. Revert the phone and stand it on the desktop.

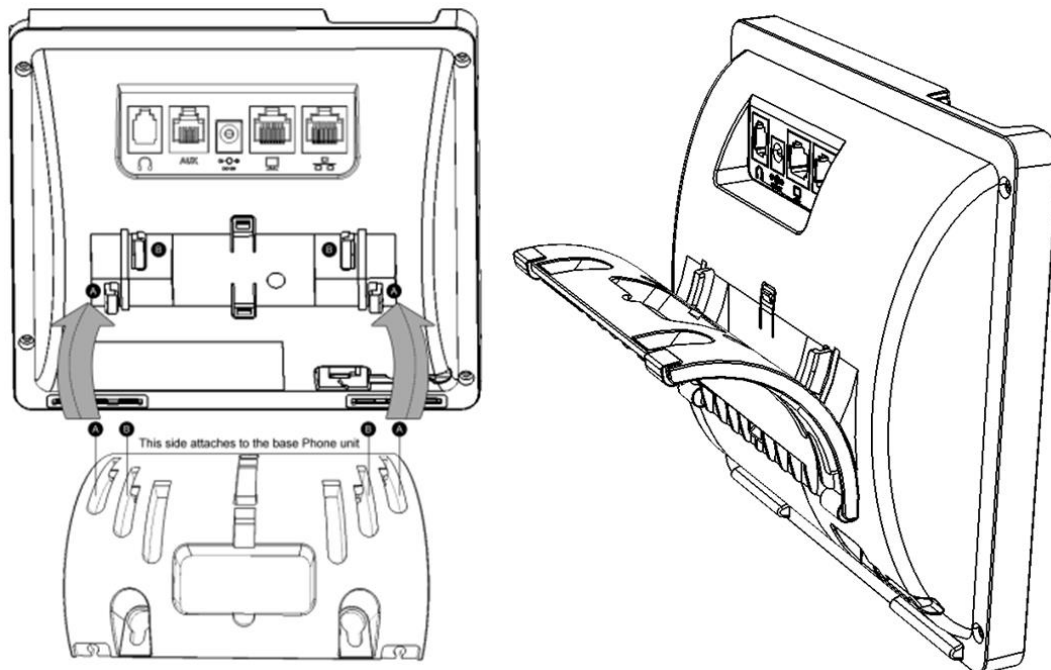

2.4.1.1 Routing the Handset Cable

The phone features a groove for routing the handset cable.

2.4.2 Wall Mounting

This section describes how to mount the phone on a wall.

To mount the phone on a wall:

1. Attach the stand of the phone for the purpose of a wall mounting:
 - a. Detach the base.

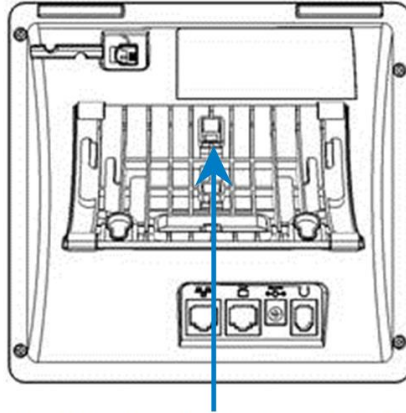

To detach the phone's stand, push this button

- b. Attach it again as you did for a desktop mounting (see Section 2.4.1) only now make sure that it's flatly aligned to lie flush against the wall, i.e., slide the *inner rails* of the phone stand onto the phone base's inner notches.

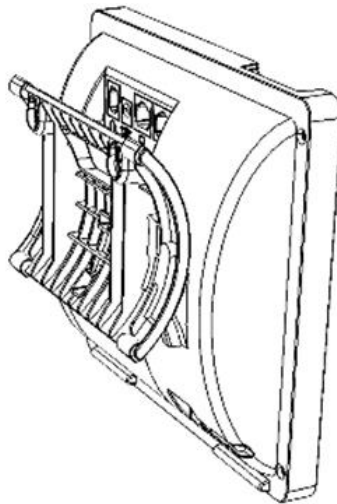

2. Connect the AC power adapter, LAN and PC/laptop cords.
3. In the wall, drill two horizontal holes at a distance of $3 \frac{15}{16}$ inches (100 mm) from one another, in line with the template.
4. Insert two masonry anchors into the holes if necessary.
5. Thread two screws (not supplied) into the two masonry anchors; ensure that the heads extend sufficiently (about $\frac{3}{16}$ inch or 5 mm from the wall) for the phone stand's keyhole slots to hang on.
6. Hang the phone stand's keyhole slots on these screws.

3 Getting Started

This section gets you started with the 445HD phone. The phone features a touch screen, providing an intuitive, menu-driven user interface for configuring the device and viewing call information.

3.1 Getting Acquainted with the Phone's Screen

The figure below shows the touch screen in idle state.

Figure 3-1: Touch Screen in Idle State



Screens images depicted in this document might vary slightly in appearance from the actual screen images on your phone.

Use the table below as reference:

Table 3-1: Touch Screen in Idle State

Reference	Description
1	Presence status: Available, Busy, Do not disturb.
	User name and phone number configured by your network administrator using the Web interface.
2	Day, Date and Month, automatically retrieved from the Network Time Protocol (NTP) server, enabled by your network administrator.
	Time, automatically retrieved from the Network Time Protocol (NTP) server, enabled by your network administrator.
3	Softkeys. See Table 3-2 for softkey descriptions.

3.2 Softkeys

The table below describes the softkeys displayed in the touch screen. Press a softkey to activate.

Table 3-2: Softkey Descriptions

Softkey	Description
Missed	Displays missed calls.
Forward	Automatically forwards calls.
DnD	Do not Disturb (see Section 8.9).
Contacts	Displayed after lifting the handset (for example). Opens the 'Personal Directory'.
Call Log	Displayed after lifting the handset (for example).
Select	Identical to the hard OK key on the phone. Either can be used. Selects a menu or option.
A/a/1	Enables switching between input modes: abc, ABC, Abc or 123.
Save	Saves settings.
Cancel	Cancels the currently initiated call or configuration.
Dial	Displayed after a number is keyed, a directory contact is selected, or a logged call is selected.
Clear	Displayed after entering a digit of a phone number (for example). Deletes from right to left.
Call Menu	Displayed after dialing a number and it's answered, and after you answer a call.
Conf	Displayed (1) after a number is dialed and the call is answered on the other side and (2) after you answer a call. Pressing it displays the ADD PARTICIPANT screen or merge a call if there are two calls.
BXfer	Lets you transfer the call in a blind transfer. The softkey is displayed (1) after a number is dialed and the call is answered on the other side and (2) after a call is answered.
URL	Displayed after lifting the handset (for example). Enables calling a URL.
Detail	Displayed after selecting a call log (for example). If selected, the details of a logged call are displayed (Time, Date, etc.).
End	Displayed after pressing the Dial softkey (for example). Ends the call.
Back	Displayed after pressing the MENU key (for example). Returns to the previous screen.
Edit	Displayed after you select a contact to be edited (for example).
Delete	Displayed after pressing the MENU key and then selecting Call Log (for example).
Silent	Silences the ring. The softkey is displayed when the phone rings for an incoming call.
Reject	Rejects the call. The softkey is displayed when the phone rings, for an incoming call.
Accept	Answers the call. The softkey is displayed when the phone rings, for an incoming call.

3.3 Navigating the Phone Menu

The **MENU** hard key on the phone lets you configure settings and access information. Press it to view call logs, configure speed dials, customize phone settings, determine device status, perform administration and access 'Contacts'. Press the key to view the phone's Menu screen.

Figure 3-2: Phone Menus

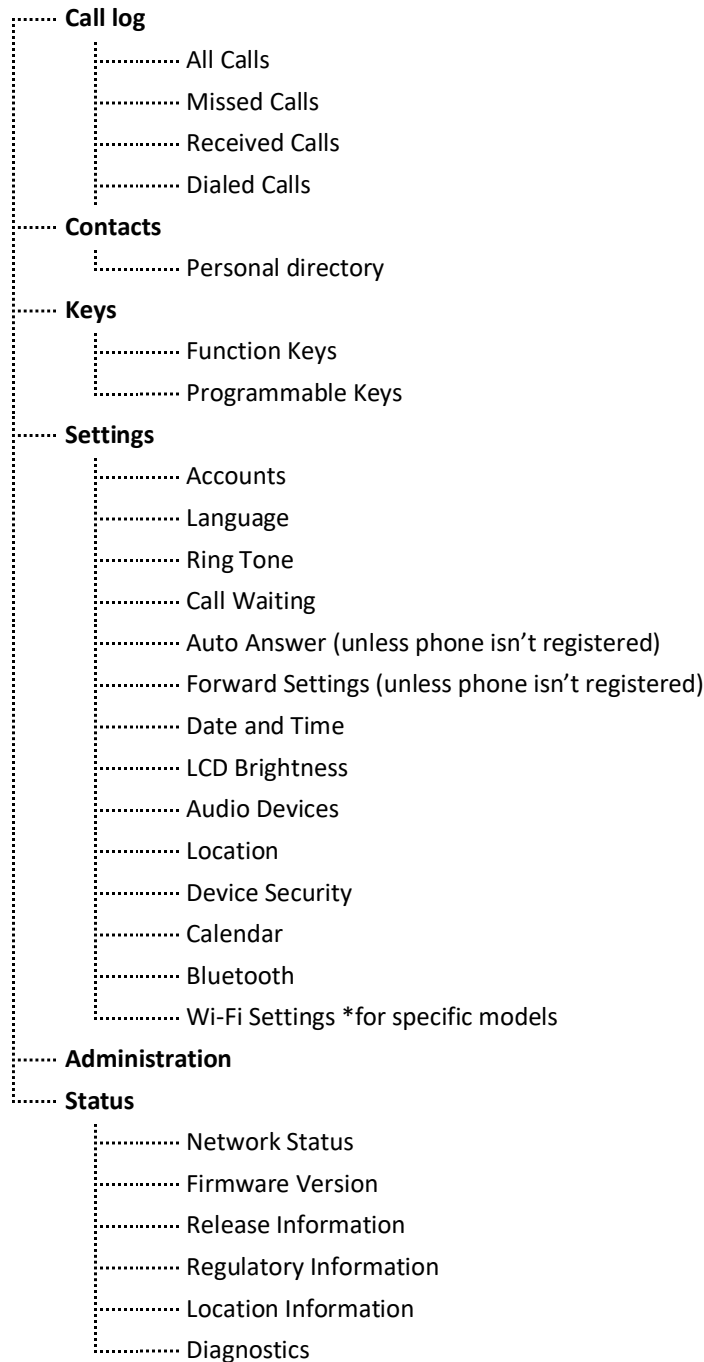

Administration is intended for network administrators only. It is password protected. See the *Administrator's Manual* for details.

To access the menu and menu items:

- Press the **Menu** softkey in the phone screen.

To navigate to menu items:

- After opening the menu, press the navigation control button's lower rim -OR- press the menu item's number, e.g., press **3** to navigate to **Keys Configuration**.

To select a menu or menu item:

- Press the navigation control's **OK** button.

To cancel and move to a previous menu level:

- Tap the **Back** softkey.

3.4 Switching between Letters and Numbers

The keypad allows you to enter upper case letters, lower case letters and numbers, and to switch from one mode to another.

To enter a contact's name (for example):

1. In the Add Contact screen, press the the # key on the keypad.

Figure 3-3: Switching between Letters | Numbers

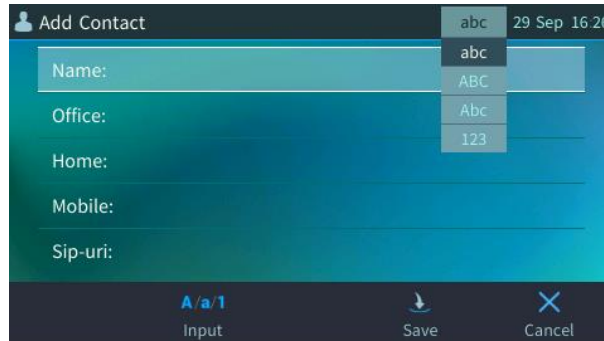

2. Press the # key successively to navigate to and select the mode:
 - **abc** = lower case letters
 - **ABC** = upper case letters
 - **Abc** = first letter upper case, the rest lower case
 - **123** = numbers
3. [For example] Select **Abc** mode and then on the keypad, press the **2** key; **A** is entered. Press the **5** key three successive times; **l** is entered (once produces **j**, twice produces **K**). Similarly, enter **a** and **n**.

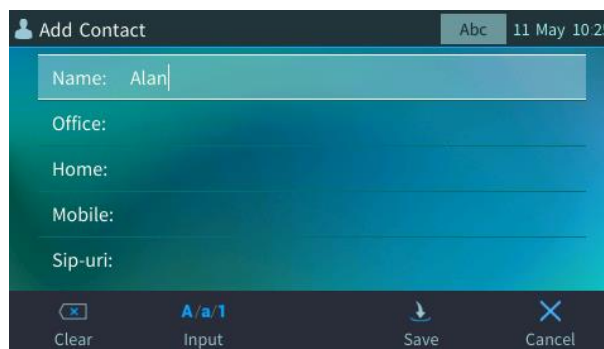

3.5 Switching to Symbols

The keypad allows you to switch to symbols and to revert from symbols mode to letters or numbers mode.

To enter a symbol (e.g., dot or @ or hyphen):

1. Press the # key successively to navigate to and select **abc** (mandatory).
2. Press the **1** key on the keypad; a period / full stop is entered. *Immediately* press the **1** key again; a backslash is entered. Pressing successively produces the following symbols:

Symbol	Explanation	Symbol	Explanation
.	Dot	*	Star sign

\	Backslash	=	Equal sign
@	At		Separator
;	Semi-colon	(Open parenthesis
:	Colon)	Close parenthesis
#	Pound	{	Open parenthesis
\$	Dollar	}	Close parenthesis
%	Percentage	[Open square parenthesis
^	Caret]	Close square parenthesis
&	Ampersand	"	Double quotation marks
!	Exclamation mark	'	Single quotation mark
?	Question mark	>	Greater than
+	Plus	<	Less than
-	Hyphen	,	Comma
_	Underscore	/	Forward slash
~	Approximates		

Note that the asterisk (*) symbol is entered directly using the star key.

Figure 3-4: Entering a Symbol, e.g., a dot

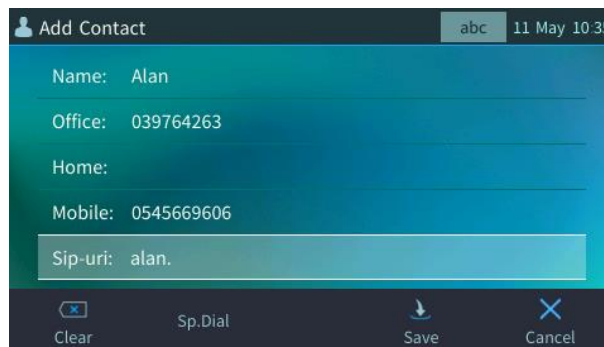

To revert to letters, e.g., abc:

- Make sure you're in **abc** mode and successively press the **7** key three times to produce (for example) **r**:

Figure 3-5: Reverting to Letters, e.g., abc

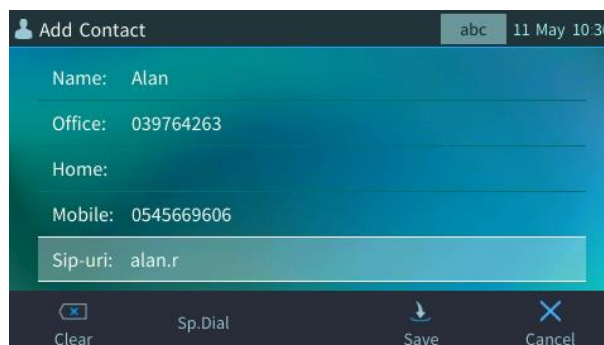

4 Configuring a Line

See the *Administrator's Manual* for information about configuring a line.

4.1 Displayed Messages

Messages indicating processes in progress, displayed in the screen, include:

Table 4-1: Displayed Messages Indicating Processes In Progress

Message	Description
Initializing	Initializing
Discovering LLDP	Discovering VLAN using Link Layer Discovery Protocol (LLDP)
Discovering CDP	Discovering VLAN using Cisco Discovery Protocol (CDP)
Acquiring IP	Acquiring an IP address from a DHCP server
Initializing Network	Initializing the network
Downloading Firmware File	Downloading a firmware file
Upgrading Firmware	Upgrading the phone's img firmware
Updating Configuration File	Upgrading the phone's cfg configuration file

4.2 Connecting to Wi-Fi



Applies only to 445HD phone models UC445HDEG-BW and UC445HDEPSG-BW.

The phone can connect to an Access Point via Wi-Fi. The Wi-Fi interface can be used when the phone is installed in an environment free of LAN/cables, to perform VoIP calls over Wi-Fi.

To connect to Wi-Fi:

1. In the phone's main menu, press the **Networks** icon -or- in the 'Settings' menu, navigate to and select the **Wi-Fi** option. If an Ethernet cable does not connect the phone to a LAN port:



If an Ethernet cable does not connect the 445HD phone to a LAN port, the phone displays a 'LAN Link Failure' message and a **Networks** softkey.

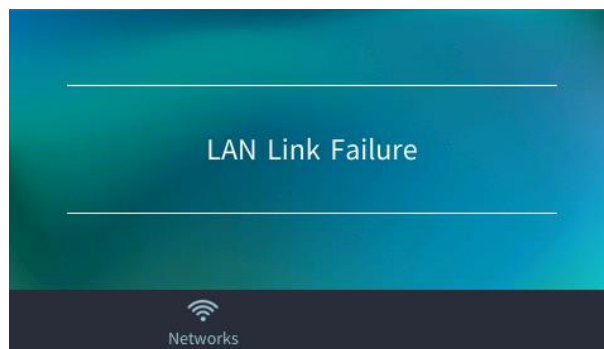

2. Alternatively access Wi-Fi settings via the MENU hard key > **Settings** > **Wi-Fi Settings**.

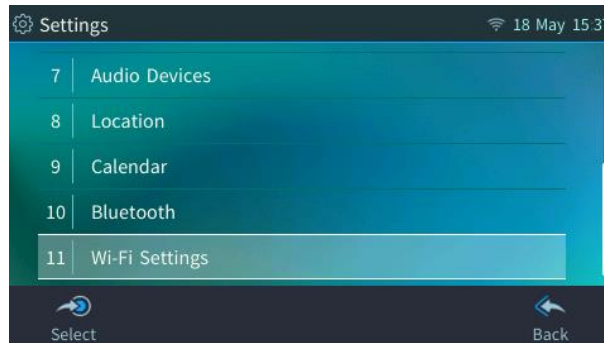

3. Enable/disable Wi-Fi by pressing the navigation button's right/left rim (Default: Disabled).

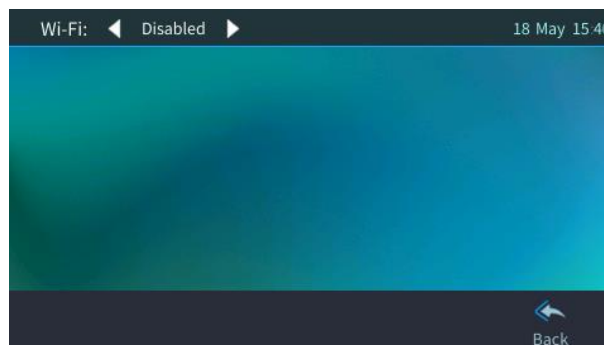

4. After enabling Wi-Fi, the phone indicates 'Searching for networks...' The phone then displays available Wi-Fi Access Points. If necessary, press the **Refresh** softkey to display more options.



5. After selecting a Wi-Fi Access Point, configure Access Point parameters.

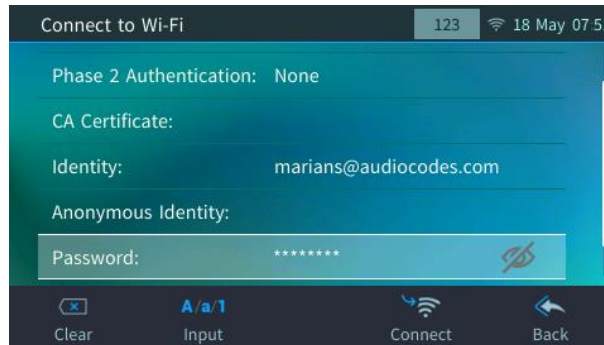

6. After configuring the Wi-Fi parameters, press the **Connect** softkey and wait about 20-30 seconds for the phone to connect to Wi-Fi and receive an IP address; the Wi-Fi icon is then displayed in the uppermost right corner of the screen:

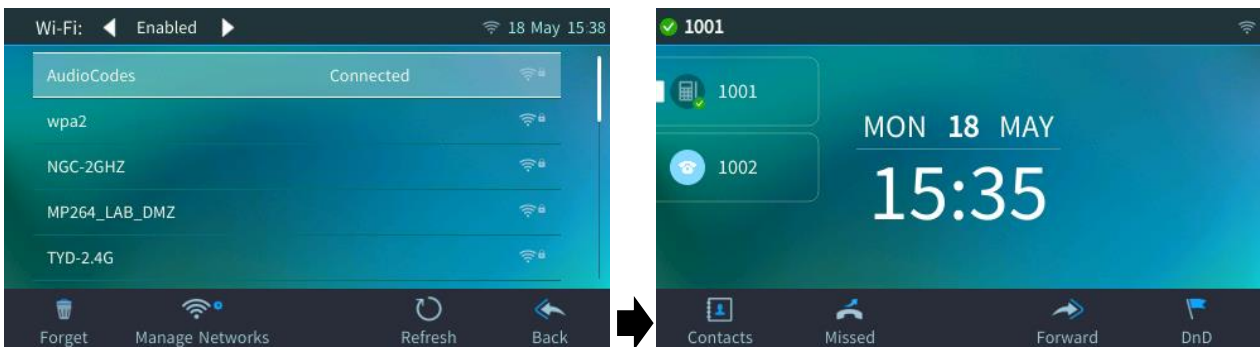

7. Determine Wi-Fi status (network name, authentication method and Wi-Fi signal strength) from the Wi-Fi Network Info screen (**Device Status > Wi-Fi**).

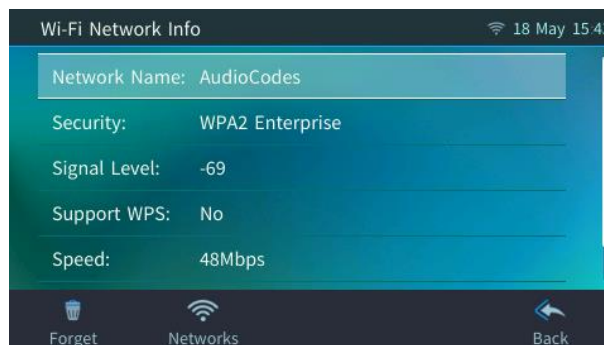

5 Using the Phone's Automatic Lock Feature

The phone is capable of automatically locking after a configured period of time to secure it against unwanted (mis)use. If left untouched for 10 minutes (default), it automatically locks and becomes inaccessible to anyone who does not know its lock code.

5.1 Enabling the Locking Feature

- Incoming calls are allowed, but outgoing calls need the lock code.
- Without the lock code, users cannot access the Call Log, Calendar and Corporate directory, but they can call preconfigured emergency numbers.



For the phone's automatic locking feature to be available to users, the network administrator must first enable it in the Skype for Business server and Web interface. See the *Administrator's Manual* for details.

After the network administrator has enabled the feature, you need to enable it on the phone (if it isn't enabled already).

When signing in for the first time, the user is prompted for the lock code. After entering a code, e.g., **123456**, confirming and saving it, the phone goes into idle state and locks after 10 minutes.

To enable the lock feature on the phone:

1. Press the MENU key, press the **Settings** item and scroll to and select **Device Security**.

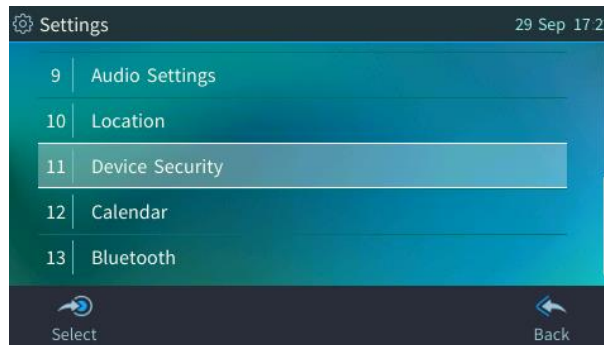

2. In the Device Security screen, select **Locking the Device**, press **Select**, and then select **Enabled**.

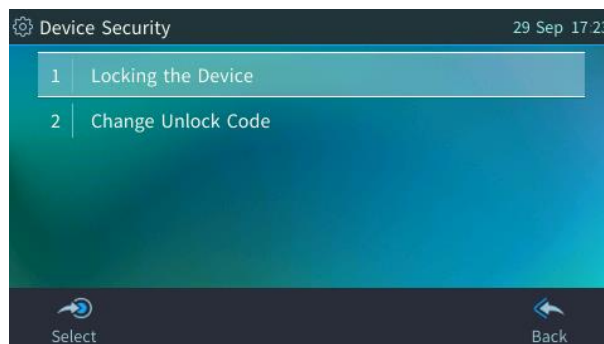

To disable the lock feature on the phone:

1. Press the MENU key, press the **Settings** item and scroll to and select **Device Security**.
2. In the Device Security screen, select **Locking the Device**, press **Select**, and then select **Disabled**.

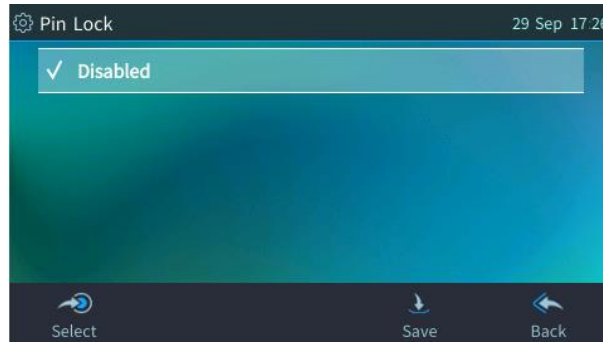

5.2 Unlocking a Locked Phone

If the locking feature is enabled, the phone automatically locks after a configured period of time, securing it against unwanted (mis)use. If left untouched for 10 minutes (default), it automatically locks and is inaccessible to anyone who doesn't know its lock code. After a phone locks:

- Outgoing calls cannot be made
- Call Log, Calendar and Corporate Directory cannot be accessed

Your network administrator if necessary, can allow making emergency calls and other capabilities even though the phone is locked. See the next section for more information.

To unlock a locked phone:

- When prompted for a lock code, enter a code, e.g., **123456**, and then press **OK**; the phone enters idle state.

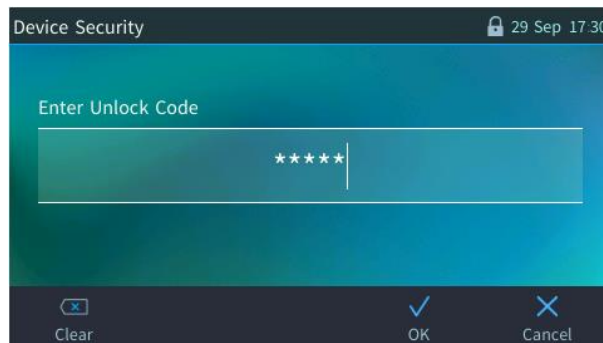

5.3 Manually Changing the Lock Code

The lock code can manually be changed as an extra security measure.

To manually change the code:

1. Press the **MENU** hard key on the phone, select **Settings** and then scroll down to select **Device Security**.
2. In the Device Security screen, select **Change Unlock Code**.

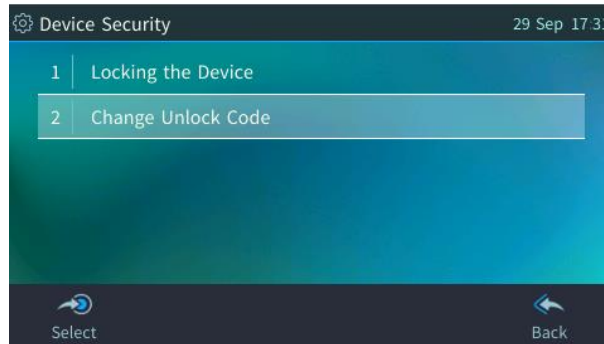

3. Enter the new unlock code, press the **Next** softkey and re-enter the code.

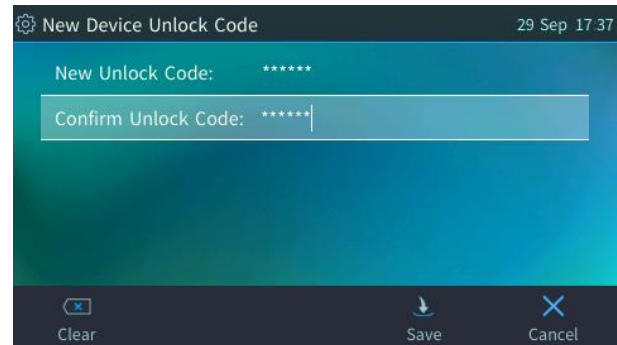
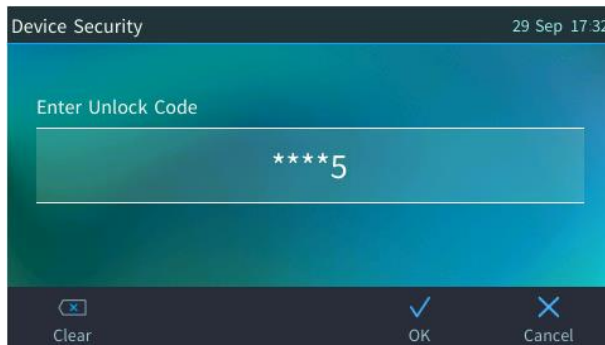

4. Press **Save**.

6 Customizing Your Phone

You can customize your phone to create a friendlier user experience.

6.1 Changing the Screen Language

The phone supports multiple languages. English is the default.

To change the default:

1. Open the **Languages** screen (**MENU** hard key > **Settings** > **Language**).
2. Navigate to and select the language you require.

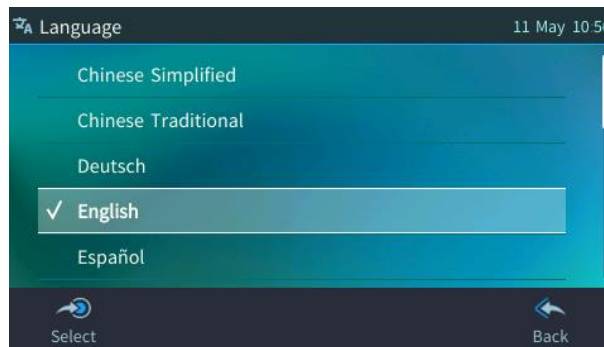

3. Press the **Save** softkey to save the setting.



6.2 Selecting Ring Tone

You can choose from a selection of ring tones to indicate incoming calls.

To select a ring tone:

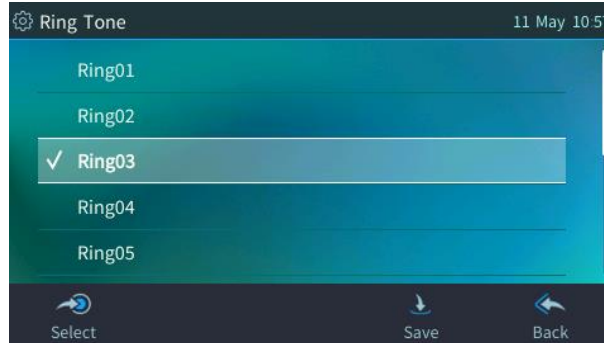
1. Open the **Ring Tone** screen (**MENU** hard key > **Settings** > **Ring Tone**).



2. Navigate to and select a ring tone (a sample of each ring tone is played as you navigate through the list).
3. Set ring tone volume by pressing the VOL  or VOL  key:
A few seconds after adjusting the volume level the Ringer Volume indication is hidden.
4. Press the **Select** softkey to apply your settings.
5. Press the **Save** softkey to save your settings.

To assign a ring tone per line extension:

1. Open the **Ring Tone** screen (**MENU** hard key > **Settings** > **Ring Tone**).

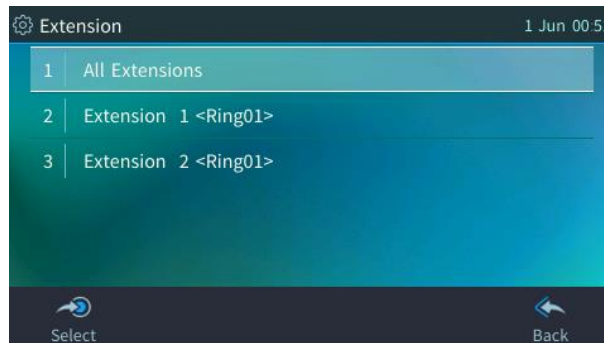

2. Navigate to and select the line extension for which to configure a ring tone.
3. In the Ring Tone screen that opens, select the ring tone of your choice and then press the **Save** softkey.

6.3 Enabling Call Waiting

You can enable or disable the call waiting feature.

To enable or disable call waiting:

1. Open the **Call Waiting** screen (**MENU** hard key > **Settings** > **Call Waiting**).

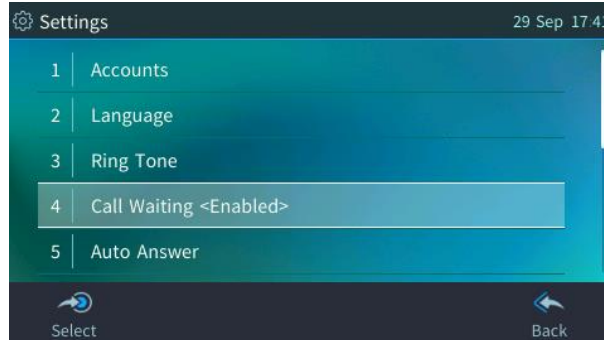

2. Navigate to and select:
 - Select **Disable** to disable call waiting
 - Select **Enable** to enable call waiting
3. Press the **Select** softkey to apply your settings.
4. Press the **Save** softkey to save your settings.

6.4 Managing Simultaneous Incoming Calls

If two calls simultaneously come in on a phone, or if a user is in a call and a third party calls, the phone's screen displays the situation in a graphically user-friendly way.

- Simultaneous incoming calls:

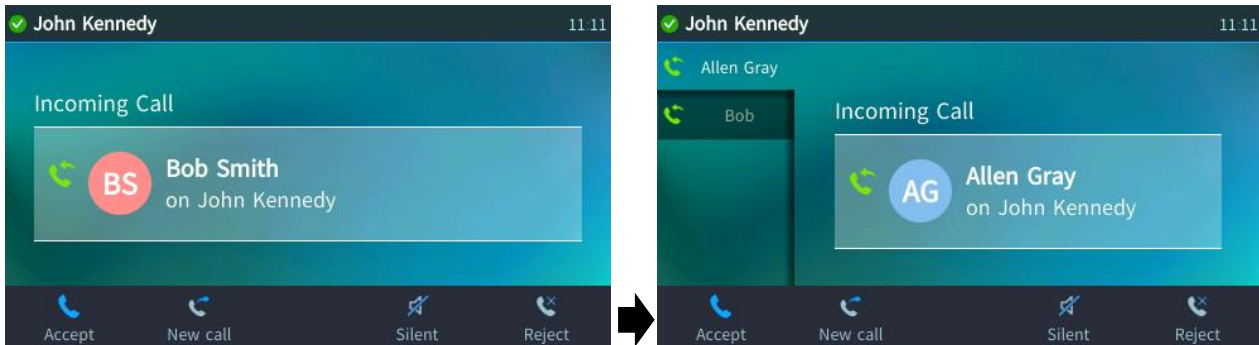

- When one of the incoming calls is answered:



- When a phone is in a call and another call comes in:



Visual indication on the device when the call comes in:

- The LED of the programmable key that is configured as an extension flashes green when a call comes in on that extension.
- The LED of the programmable key that is configured as an extension is illuminated red after a call that comes in on that extension is answered.
- The LED in the upper right corner of the device flashes blue when a call comes in.

6.5 Configuring Call Forwarding

This feature enables you to automatically redirect an incoming call to another phone number, including a mobile phone number, if a user-defined condition is met, e.g., if the line is busy. All Call Forwarding options can be configured from the phone.



[Support pending] If your enterprise deployed BroadSoft's BroadWorks server, your network administrator can control the Call Forwarding feature on the phone from the server. For more information, see the *Administrator's Manual*.

To configure call forwarding:

1. Open the **Automatic Forward** screen (MENU hard key > **Settings** > **Forward settings** -or- press the **Forward** softkey when the screen is in idle state):

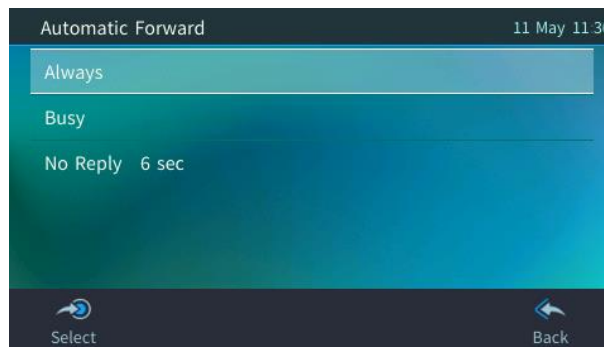

2. In the Automatic Forward screen, select either:
 - **Always:** incoming calls will always be forwarded
 - **Busy:** incoming calls will be forwarded when the user is using the phone
 - **No Reply 6 sec:** incoming calls will be forwarded if the user doesn't answer after a specified number of seconds; the default is **6** but you can configure up to **98** seconds.
3. After the selection, configure the phone number to which you want the calls to be forwarded.

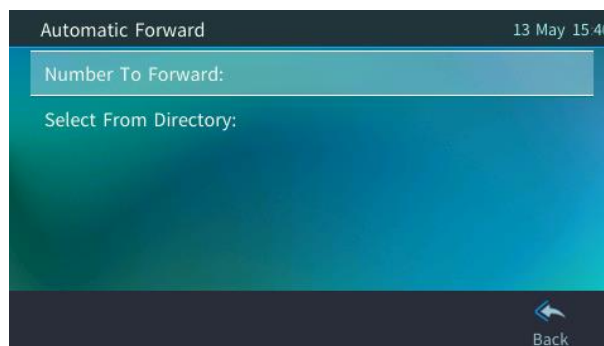

4. Alternatively, navigate to and select the **Select From Directory** option and then choose the contact to whose number you want the calls to be forwarded.
5. Press the **Start** softkey that's then activated; you're returned to the idle screen; in the idle screen, view a check mark in the corner of the **Forward** softkey; calls will automatically be forwarded to the configured number.

To configure call forwarding on multiple lines:

1. Open the **Forward** screen (press the **Forward** softkey when the screen is in idle state).

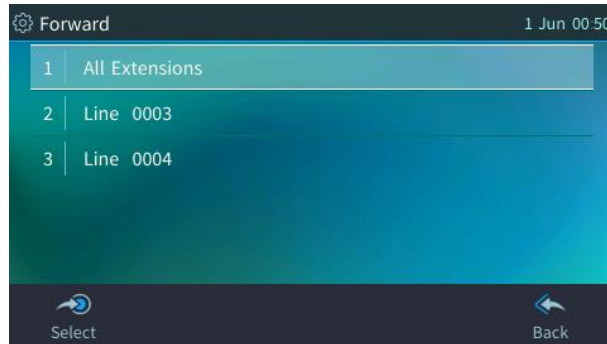

2. Navigate to and select the line extension on which to configure call forwarding; the Automatic Forward screen is displayed, as shown in the previous instruction set.
3. Configure call forwarding on that line extension and then proceed to the next line extension on which you want to configure call forwarding.

To stop call forwarding:

- When the phone is in idle state, press the **Forward** softkey; the check mark in the corner disappears.

6.6 Configuring Time and Date Settings

This section shows how to make sure the NTP server is enabled, configure enabling / disabling obtaining time zone from the DHCP server, configure the time format and configure the date format.

6.6.1 Making Sure the NTP Server is Enabled

You can manually set date and time displayed on your phone but if a Network Time Protocol (NTP) server is deployed and enabled by your administrator, date and time are automatically retrieved over the Internet from the server and manually setting them will not be possible. You'll then receive a message **Set by NTP**.



- It's recommended to implement an NTP server. If the phone's 'NTP server' setting is set to 'Disabled', inform the network administrator. Only the network administrator can change it. It must be set to 'Enabled' for date and time to be automatically retrieved from the NTP server. System administrators can see the *Administrator's Manual* for detailed information.
- If date and time are manually set, the settings are not retained after rebooting the phone or powering off. You will need to manually reset date and time if you reboot or power off.

To make sure the NTP server is enabled:

1. Open the Date and Time screen (**MENU** hard key > **Settings** > **Date and Time**).

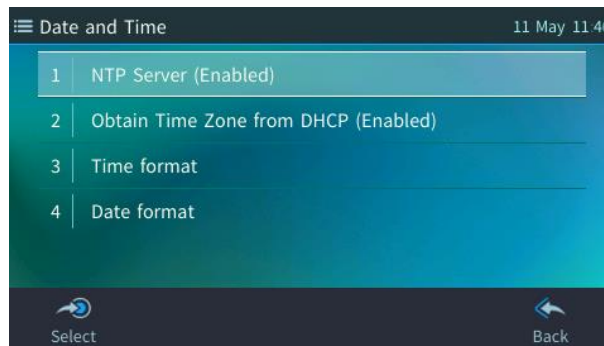

2. Select **NTP Server**.
3. If not already 'Enabled', notify your network administrator.



To configure the NTP server, see the *Administrator's Manual*.

To enable/disable obtaining time zone from the DHCP server:

1. Open the Date and Time screen (**MENU** hard key > **Settings** > **Date and Time**).

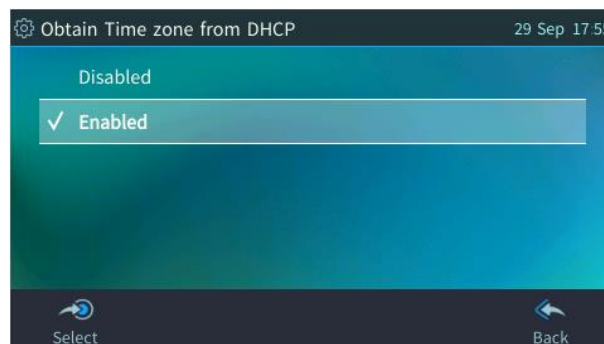

2. In the Date and Time screen shown above, select **Obtain Time Zone from DHCP**.



If 'Obtain Time Zone from DHCP' is set to **Disabled**, inform the network administrator. Only the network administrator can change the setting on the phone because it is password secured.

To configure the time format:

1. Open the Date and Time screen (**MENU** hard key > **Settings** > **Date and Time**).
2. Navigate to and select the **Time format** option and then select the format of your choice.

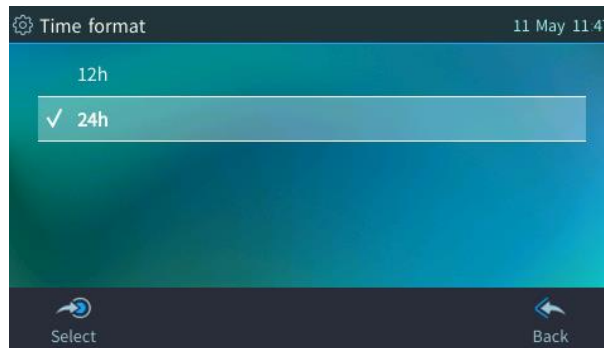

To configure the date format:

1. Open the Date and Time screen (**MENU** hard key > **Settings** > **Date and Time**).
2. Navigate to and select the **Date Format** option and select the format of your choice.

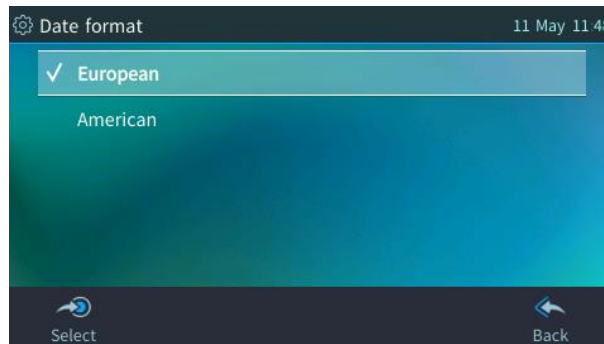

6.7 Configuring Screen Brightness

The phone's screen supports different brightness levels. You can choose the level that suits you best.

To configure screen brightness:

1. Open the LCD Brightness screen (**MENU** hard key > **Settings** > **LCD Brightness**).

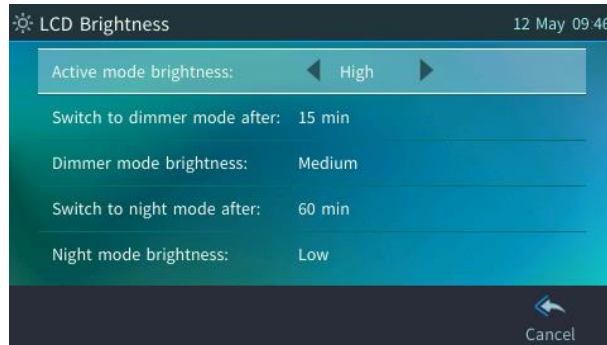

2. Navigate down to an option and then navigate to the level that suits you best. Use the table below as reference.
3. Press the **Save** softkey to apply the setting.

Table 5-1: Screen Brightness Options

LCD Brightness Option	Description
Active mode brightness	Defines the brightness of the screen when it's in 'active mode', which is for example after a calendar reminder pops up in your screen or when a call comes in or after you press a key on the dialpad. <ul style="list-style-type: none"> ■ Low ■ Medium ■ High (default)
Switch to dimmer mode after	Defines the timeout of 'active mode', in minutes. If it expires, the screen changes to 'dimmer mode' (see the next description). Configure either 15 (default), 30, 45 or 60 minutes.
Dimmer mode brightness	Defines the brightness of the screen when it's in 'dimmer mode'. The screen changes to 'dimmer' mode after the timeout configured for 'active mode' expires (see above). You can configure either: <ul style="list-style-type: none"> ■ Low ■ Medium (default) ■ High
Switch to night mode after	Defines the timeout of 'dimmer mode', in minutes. If it expires, the screen changes to 'night mode'. Configure either 30, 60 (default), 90 or 120 minutes.
Night mode brightness	Defines the brightness of the screen when it's in 'night mode'. The screen changes to 'night mode' after the timeout configured for 'dimmer mode' expires (see above). You can configure either: <ul style="list-style-type: none"> ■ Low (default) ■ Medium ■ High

6.8 Configuring a Default Audio Device

Users can configure a default audio device. This is the device that's used when the user presses the **Accept** key to answer calls or when the user dials using speed dial.

The default audio device is the speaker.

To change the default:

1. Open the Select Audio Device screen (MENU key > **Settings** > **Audio Settings** > **Audio Devices**)

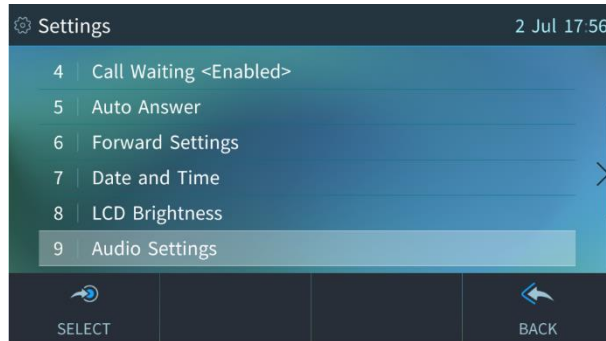

2. Navigate to and select **Analog Headset** or other connected USB/Bluetooth entities and then **Set as Default**.



3. Press the **Save** softkey.

6.9 Adjusting Volume



The phone allows you to adjust

- Ring volume
- Tone volume (e.g., dial tone)
- Handset volume
- Speaker volume
- Headset volume

6.9.1 Adjusting Ring Volume

The volume of the phone's ring alerting you to an incoming call can be adjusted to suit personal preference.

To adjust ring volume:

1. When the phone is in idle state, press the VOL  or VOL  key; the Ringer Volume bar is displayed on the screen.

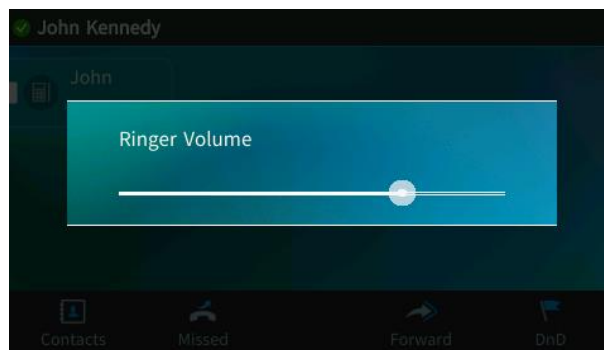

2. After adjusting, the Ringer Volume level disappears from the screen.





You can alternatively press the upper and lower rim of the navigation control button to increase or decrease ring volume, tones volume or call voice volume. When you press the **OK** on the navigation control button, the volume screen disappears.

6.9.2 Adjusting Tones Volume

The phone's tones, including dial tone, ring-back tone and all other call progress tones, can be adjusted to suit personal preference.

To adjust tones volume:

1. Off-hook the phone (using handset, speaker or headset).
2. Press the VOL  or VOL  key; the Tones Volume bar displays on the screen.

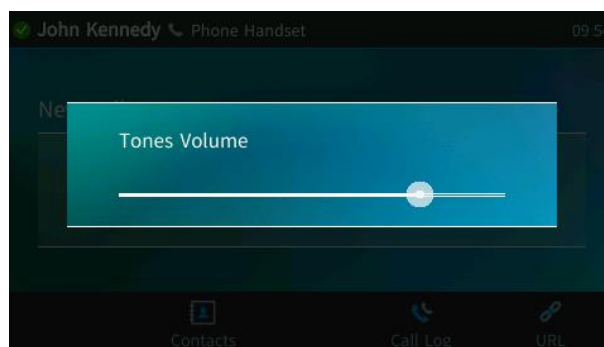



3. After adjusting, the Tones Volume bar disappears from the screen.

6.9.3 Adjusting Handset Volume

The volume of the handset can be adjusted to suit personal preference. The adjustment is performed during a call or when making a call. The newly adjusted level applies to all subsequent handset use.

To adjust handset volume:

1. During a call or when making a call, make sure the handset is off the cradle.
2. Press the VOL  or VOL  key; the Handset Volume bar is displayed on the screen.

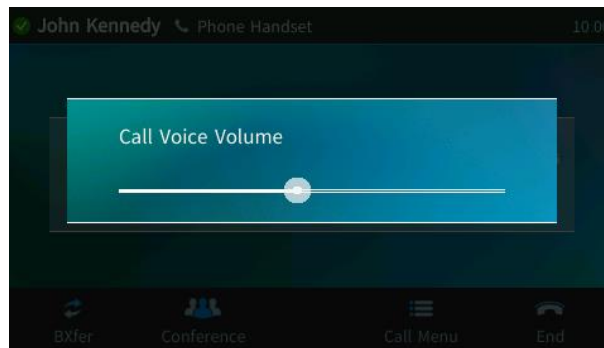



3. After adjusting, the Handset Volume bar disappears from the screen.

6.9.4 Adjusting Speaker Volume

The volume of the speaker can be adjusted to suit personal preference. It can only be adjusted *during a call*.

To adjust the speaker volume:

1. During a call, press the speaker hard key on the phone.
2. When the phone is in idle state, press the VOL  or VOL  key; the Speaker Volume bar is displayed on the screen.

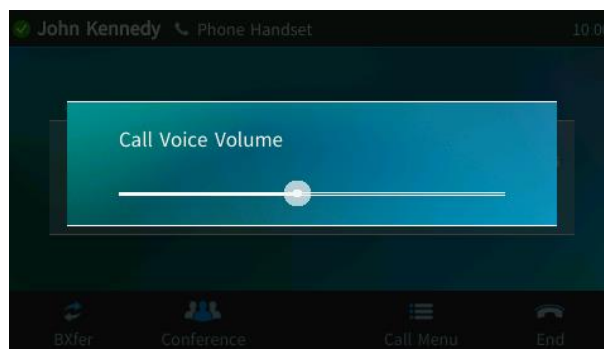



3. After you have completed adjusting the volume, the Speaker Volume bar disappears from the screen.

6.9.5 Adjusting Headset Volume

The volume of the headset can be adjusted to suit personal preference. It can only be adjusted *during a call*.

To adjust the headset volume:

1. During a call, press the headset hard key on the phone.
2. Press the VOL  or VOL  key; the Headset Volume bar is displayed on the screen.

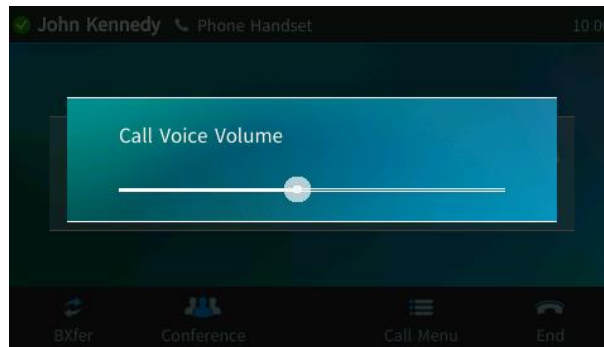

3. After you have completed adjusting the volume, the Headset Volume bar disappears from the screen.

6.10 Managing your Personal Directory

The phone supports the Personal directory.



- You can add, edit and delete contacts in the Personal directory.
- You can add a maximum of 1,000 contacts to your Personal directory. After adding a contact, you can call the contact directly from the directory. If you receive an incoming call from a contact listed in the directory, the screen displays the name listed.
- The Personal directory displays the presence status of contacts (depending on server BLF support).
- If you assign a speed dial key to a contact, you can press it to call them.

6.10.1 Adding a Contact to the Personal Directory

The home number, office number, mobile number and/or SIP URI of a contact can be added to the Personal Directory. You can also configure a speed dial to place calls quickly to the contact (see Section 6.12, Configuring a Function/Programmable Key as a Speed Dial). After adding the contact, you can search for them in the group, dial them, edit their contact information or delete them.



You can add a maximum of 1,000 contacts to your Personal Directory. After adding a contact, you can call the contact directly from the directory. If you receive an incoming call from a contact listed in the directory, the touch screen displays the name listed.

To add a contact to the Personal directory:

1. Open the Personal directory (press the CONTACTS hard key on the phone).

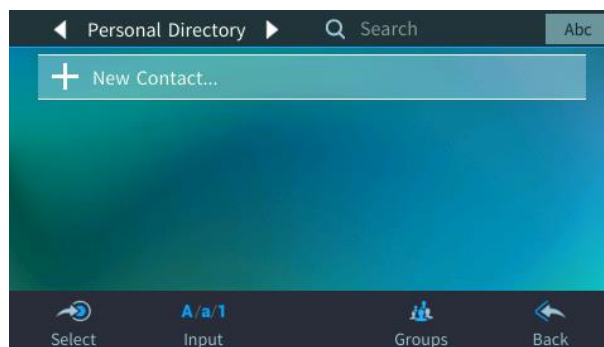

2. Select **+ New Contact**.



3. In the 'Add Contact' screen, key in the 'Name' of the new contact.
4. Navigate down and key in the new contact's office phone number.
5. [Optionally] Navigate down and key in the new contact's home and mobile numbers as well.
6. [Optionally] Navigate down and enter their SIP URI, e.g., mike.dubb@audiocodes.com. This option can be useful to you if you don't know their phone number.
7. Press the **Sp. Dial** softkey to assign a speed dial key if required.

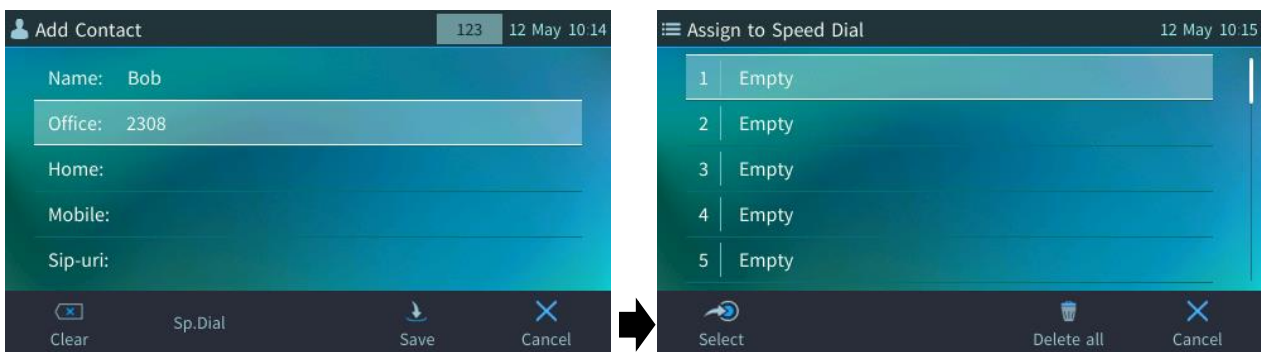

8. Navigate to and select the first 'Empty' speed dial, and then save it; the speed dial key is displayed in the phone's sidecar.

6.10.2 Editing Contact Information

Information about a contact in the Personal directory can be edited. This is important if a contact changes their phone number, for example.

To edit contact information:

1. Open the Personal directory (press the CONTACTS hard key on the phone), navigate to the name of the contact whose information you want to edit and then press the **OK** hard key on the phone.

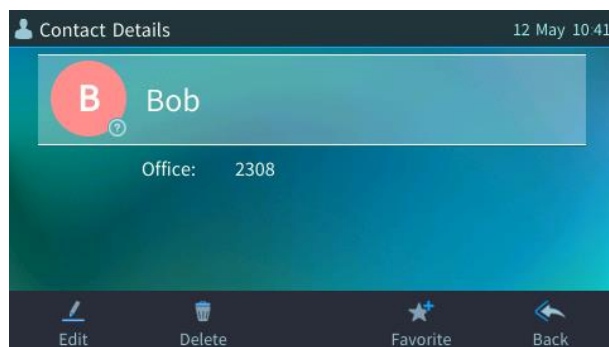

2. Press the **Edit** softkey.

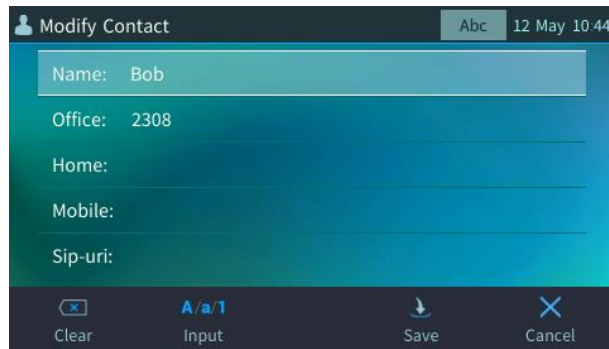

3. Edit the contact's details and press **Save**.

6.10.3 Deleting a Contact from the Personal Directory

Contacts can be deleted from the Personal directory. This can be necessary if they leave the company, for example.

To delete a contact:

1. Open the Personal directory (press the CONTACTS hard key on the phone), navigate to the name of the contact to delete and then press the **OK** hard key on the phone.

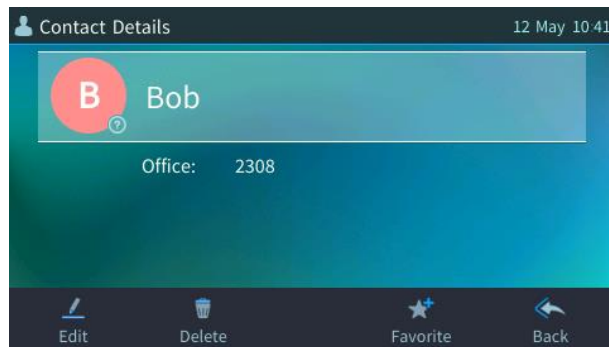

2. Press the **Delete** softkey; a 'Delete current contact?' warning message appears:

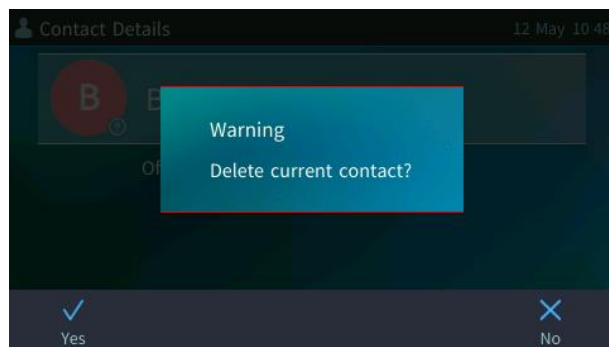

3. Press the **Yes** softkey to remove the contact from the phone directory or **No** if you want to keep the contact in the directory.

6.10.4 Searching for a Contact in the Personal Directory

The search feature enables you to quickly and easily locate a contact in a directory. The feature increases user productivity, especially if you have a long list of contacts.

To search for a contact in the Personal Directory:

- Open the Personal Directory and then
- 1. Navigate down to the contact in the list
- 2. Search for a contact:
 - Scroll down to the contact in the list
 - OR-
 - a. Key the first letter in the contact's name; the directory locates contacts whose names begin with that letter. For example, as you press the **J** key to search for contact Jonathan, the directory locates contacts whose names begin with **J**. As you key in the next letter, i.e., **o**, contacts whose names begin with **Jo** appear, etc.

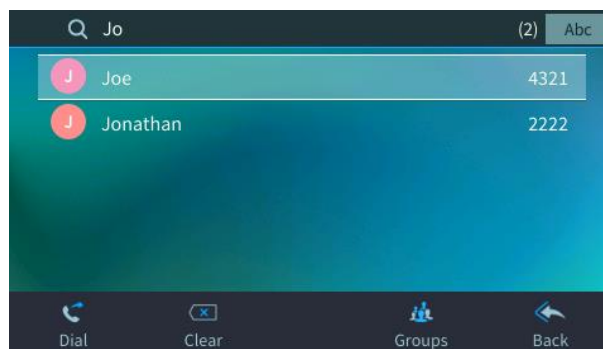

- b. Key the next letter (if necessary), **n**.

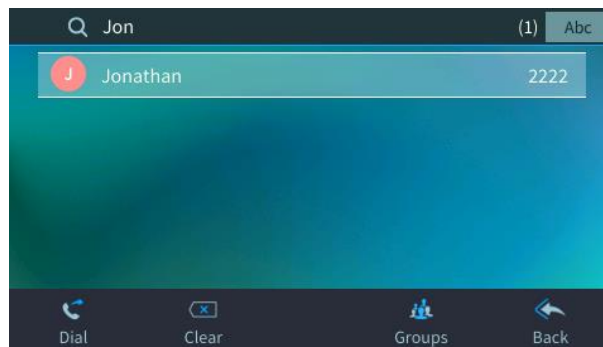

- If you key in a letter and there are no matching entries in the Personal Directory, you'll be indicated **No Matches**. To exit, press **OK** to accept the result, **Back** to exit from the Contacts and **Clear** to allow a new search.

6.11 Programmable Softkeys (PSKs)

Located under your phone's LCD are four configurable softkeys. The idle screen by default displays (from left to right) **Contacts**, **Missed**, **Forward**, and **DnD** softkeys.



PSKs can only be configured by the network administrator (see the *Administrator's Manual*).

The four softkeys can be configured for different key events. The administrator can add additional softkeys. When additional softkeys (more than four) are added, the rightmost softkey is set to **More**. If you press it, you're scrolled to the next page of the softkey display.



You can scroll up to seven pages according to the supported number of configured softkeys (see the *Administrator's Manual*).

When a PSK is configured to connect to a voicemail server or to access an intercom, for example, you can be prompted after pressing the voicemail softkey to enter a personal voicemail code. After entering the voicemail code, you can press **Start** to dial to the voicemail server, **Clear** to clear the entry or **Cancel**.

6.11.1 Customized UI Experience



Only the network administrator can configure this feature. See the phone's *Administrator's Manual* for more information.

Users and / or enterprise management can ask their network manager to customize the **New Call** screen, **Ongoing call** screen and/or **Idle** screen.

Examples include:

- The softkey in the idle screen can be replaced with another softkey such as the **Received Calls** softkey.
- The ongoing call screen can be customized: The **BXfer** softkey for example can be replaced with the **New Call** softkey on the phones of users who infrequently transfer calls.

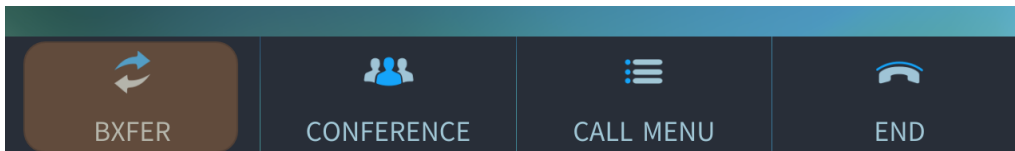

- The initiate call screen can also be customized: The **URL** dialing softkey, for example, can be replaced with the **Contacts** softkey.



- Administrators can customize the idle screen (shown in the figure below) in line with the preferences / requirements of enterprise management and / or the employees.



- For example, the **Contacts** softkey in the idle screen shown in the preceding figure can be replaced with the **Call** softkey shown in the figure below.



6.12 Configuring a Function/Programmable Key as a Speed Dial



Functional keys are available with expansion module.

Speed dials are private. They're for each user's own personal use. They're preserved even if you sign out, sign in as another user, sign out as that user, and then sign in again as your own user.

Any of the Function/Programmable Keys can be configured as a Speed Dial in the phone's idle screen. The instructions below apply for functional keys, but the principle is identical to programmable keys.

To configure a Function/Programmable Key as a Speed Dial:

1. In the phone's idle screen, long press the Function/Programmable Key .

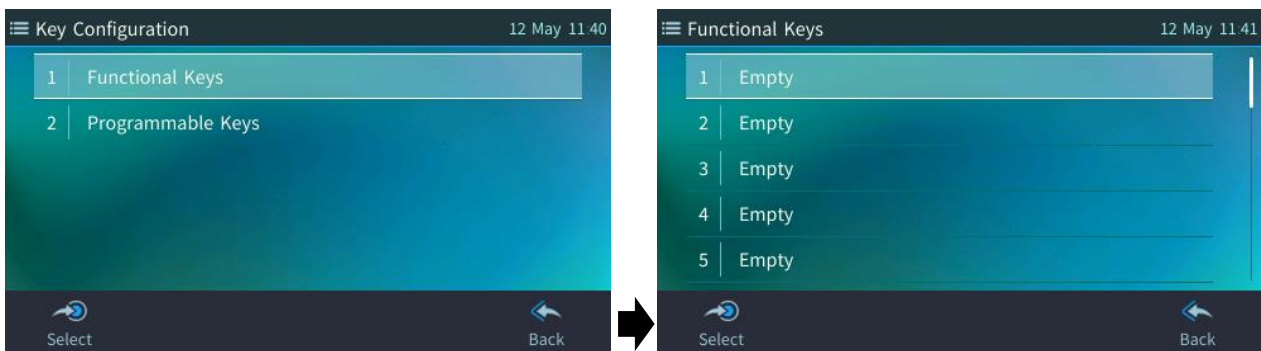

2. Navigate to and select an empty (unconfigured) Function Key.

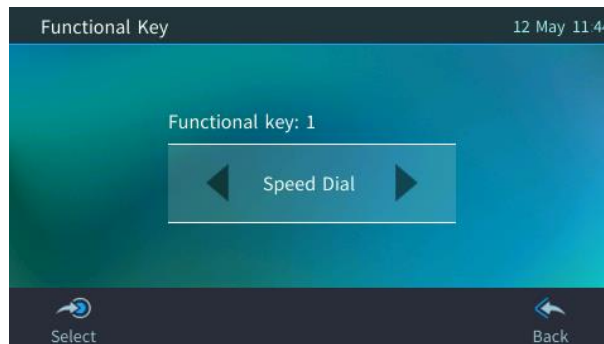

3. Press < or > to navigate to and select **Speed Dial**.

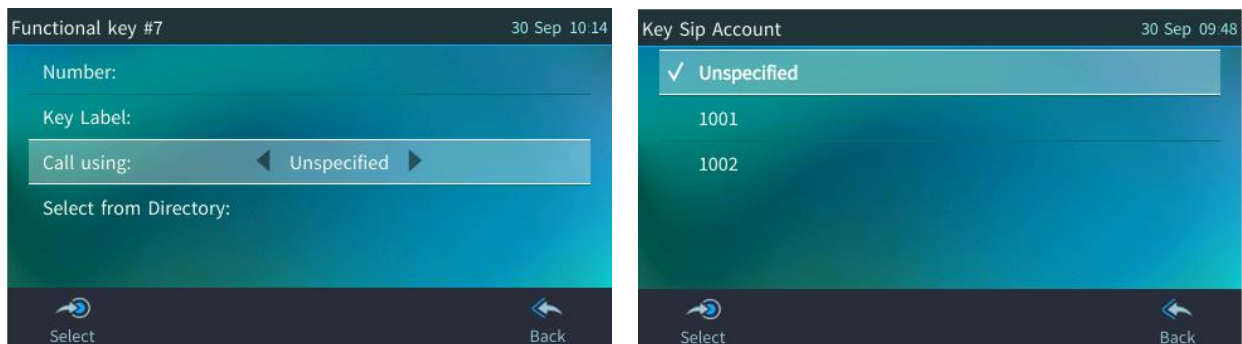

4. Select **Call using** followed by < or > to determine which phone line this speed dial uses.
5. Enter the number of the contact or select the contact from a directory.
6. Enter a Key Label – the name of the contact to be displayed on the sidecar.
7. Press the displayed **Save** softkey.

6.12.1 Configuring a Programmable Key for Speed Dialing via Calling Line of Choice

You can configure a Programmable Key for speed dialing to be initiated by a speed dial calling line of your choice. The feature only applies to a conference phone configured with multiple lines.

The feature determines through which line the call goes out when speed dialing. For example: A phone is configured with two lines, 0002 and 0003. When configuring a speed dial, 0002 or 0003 can be configured as the default line through which to (speed) dial out. For example, one line may be for internal calls, the other for external calls.

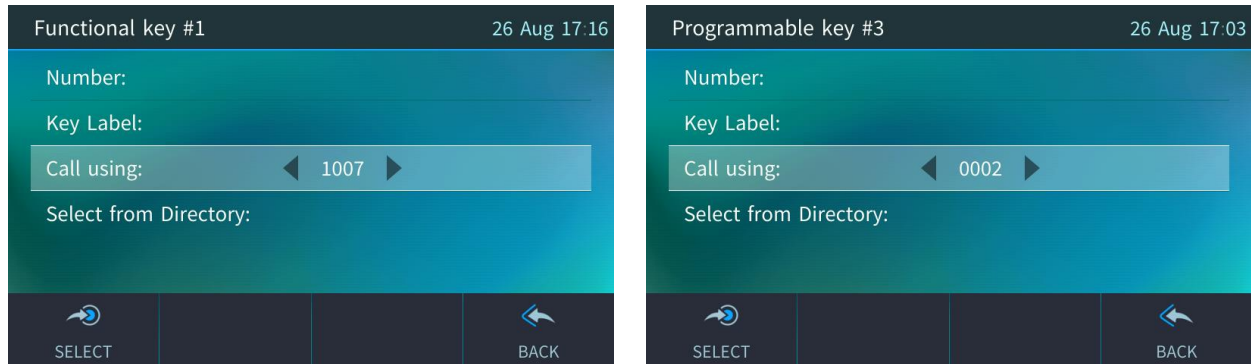

6.12.2 Configuring Pause Dialing for a Speed Dial to an Ext. behind an IVR

Your network administrator can configure pause dialing for a Speed Dial, in order to create a time break. This is typically required for a Speed Dial which dials a destination extension number that is behind an Interactive Voice Response (IVR) system.



Consult your network administrator if you need a pause dialing configured for a Speed Dial. See the *Administrator's Manual* for more information.

6.12.3 Configuring a Speed Dial Key through the Personal Directory

You can configure a Speed Dial key through the Personal Directory.

To configure a Speed Dial key through the Personal directory:

1. Open the 'Personal directory' (**MENU** key > **Contacts** > **Personal directory**), select the contact and then press the **Edit** softkey.
2. Navigate to the phone number for which to define a speed dial and press the **Sp. Dial** softkey.
3. Navigate to an 'Empty' or to a previously defined speed dial number. In the latter case, the previously defined speed dial number will be overwritten.
4. Press the **Select** softkey and then navigate to and select an 'Empty' Function Key.
5. Press the **Save** softkey; the Speed Dial is assigned to the contact and displayed in the sidecar.

6.12.4 Configuring a Speed Dial Key in the Sidecar Fields

You can configure up to 33 Speed Dials in the sidecar fields.

To configure a Speed Dial key in a sidecar field:

1. On the sidecar, long-press a button adjacent to a field.
2. In the Functional Key screen that opens, select **Speed Dial**.
3. In the 'Function Key #n' screen that opens, configure the phone number of the contact to whom to assign the Speed Dial key.
4. Enter a label that will facilitate quick and easy identification of the key.
5. Press the **Save** softkey; the field displays the name of the contact to whom you assigned the Speed Dial.

6.12.5 Editing a Speed Dial

Editing a speed dial will usually be necessary if a contact's phone number changes.

To edit a speed dial:

1. In the phone's idle screen, long press the Function/Programmable Key.

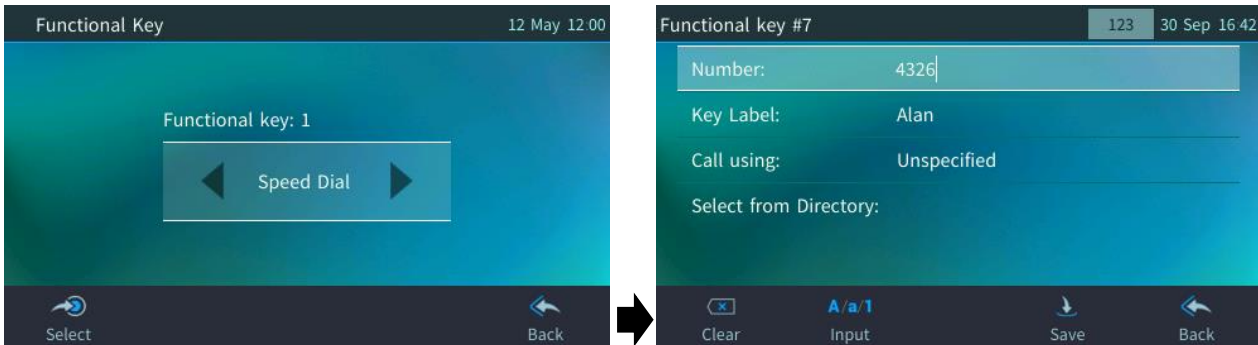

2. In the 'Number' field of the Function Key screen, press the **Clear** softkey to delete digits.
3. Navigate to the 'Key Label' field and edit by pressing the **Clear** softkey to delete letters.
4. Save the edit.

6.12.6 Deleting a Speed Dial

To delete a Speed Dial:

1. In the phone's idle screen, long press the Function/Programmable Key.
2. Navigate to 'Empty' and then press the **Select** softkey.

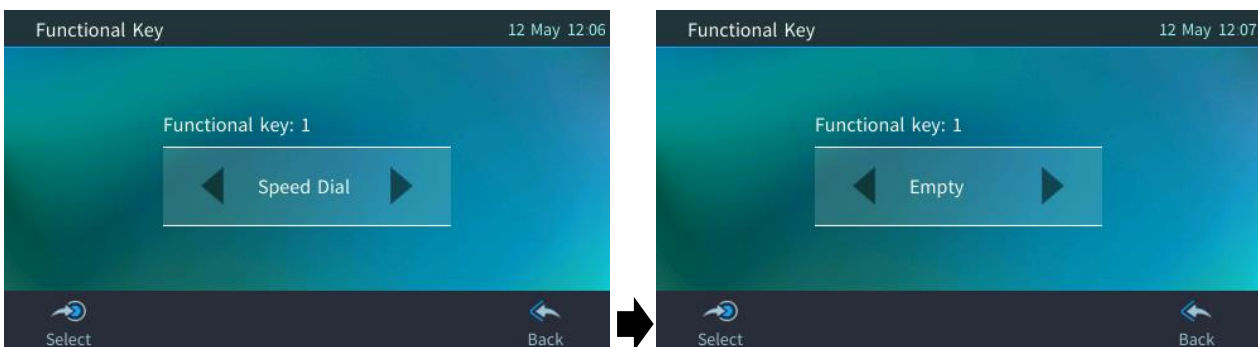

3. Press < or > to navigate to and select **Empty**.
4. The idle screen appears, and the Speed Dial is removed.

6.13 Configuring a Function/Programmable Key as a Key Event

Any of the Function/Programmable Keys can be configured as a Key Event. In the figure below, for example, Function/Programmable Key 1 has been configured as a 'Calendar' Key Event. Pressing it opens the Calendar screen.

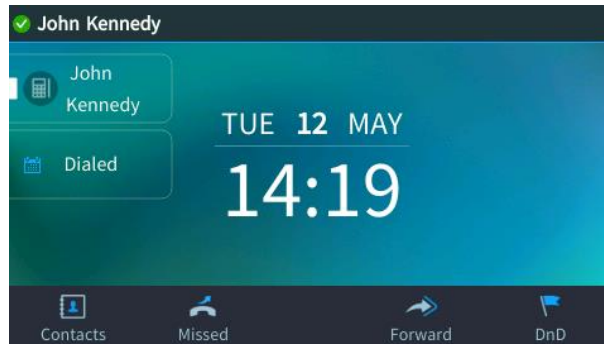

For the calendar to be displayed, you need to have signed in with User Name and Password. If you haven't, you're notified 'Calendar is not available for PIN code login'. See also under troubleshooting in Section 9.

Other Key Events you can configure:

- Missed Calls
- Received Calls
- Dialed Calls
- Contacts
- DnD All
- Forward All
- Notifications

The section below shows how to configure a Function/Programmable Key as a Key Event.

To configure a Function/Programmable Key as a Key Event:

1. In the phone's idle screen, long press the Function/Programmable Key .



Alternatively, you can press the **MENU** hard key, press the **Keys** item; that opens the functional key settings screen.



2. Press < or > to navigate to and select **Key Event**.

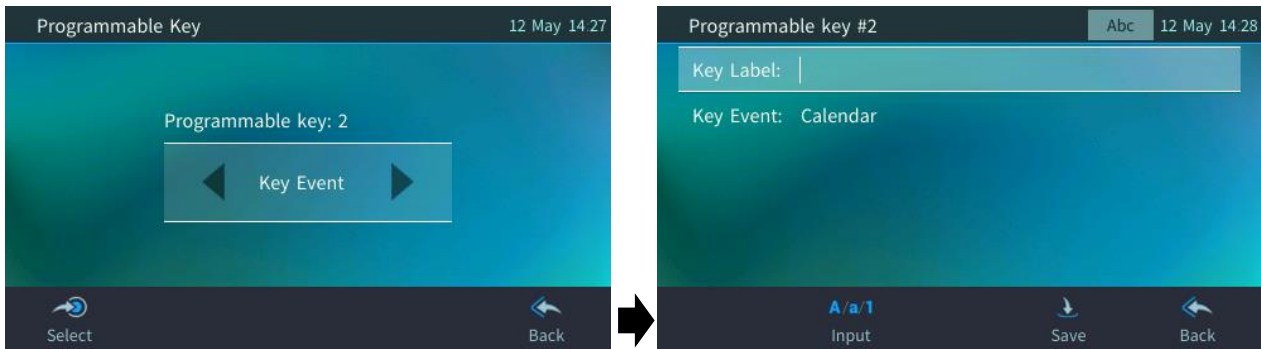

3. In the 'Key Label' field, define an identifier that you'll easily identify in your idle screen.
4. Press the 'Key Event' field and then press < or > to navigate to and select the Key Event you want to configure, for example, 'Calendar' (default).

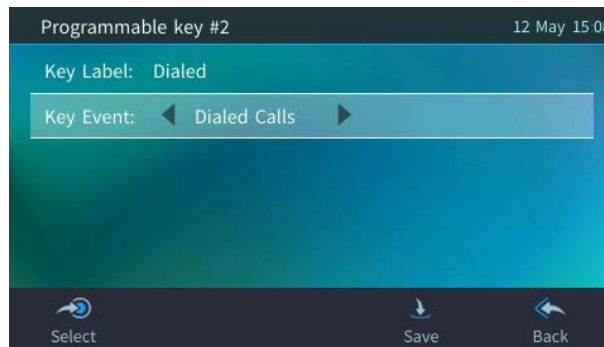

5. Press the **Save** softkey; the screen reverts to idle mode displaying the Key Event you configured.

6.14 Configuring a Function/Programmable Key for Direct Voice Dialing

Any of the Function/Programmable Keys can be configured for Direct Voice Dialing. The phone is directly integrated with AudioCodes' Voca services to allow voice dialing to any other user in same corporate directory. To enable the service, the user must add a VocaNOM function key.



The network administrator must enable the feature and configure the VocaNOM IP address service on the phone for the Function/Programmable Key to be activated. See the *Administrator's Manual* for more information.

VocaNOM allows voice-dialing colleagues by pressing the VocaNOM key in the phone's idle screen or in the Expansion Unit screen. A beep is played and then a voice prompt requests first and last name or department. The caller articulates the first and last name and then at the prompt, articulates "Office" or "Mobile". The VocaNOM service then directly dials the requested party according to the instructions articulated by the user.

When the service identifies the requested party, the phone dials their number just as it does in a regular call. Later, the user can press the REDIAL hard key on the phone and view the call logged in the phone's 'Dialed Calls' just like with any other call.

The VocaNOM voice-dialing feature increases day-to-day work productivity.

To configure a Function/Programmable Key for direct voice dialing:

1. In the phone's idle screen, long press the Function/Programmable Key .

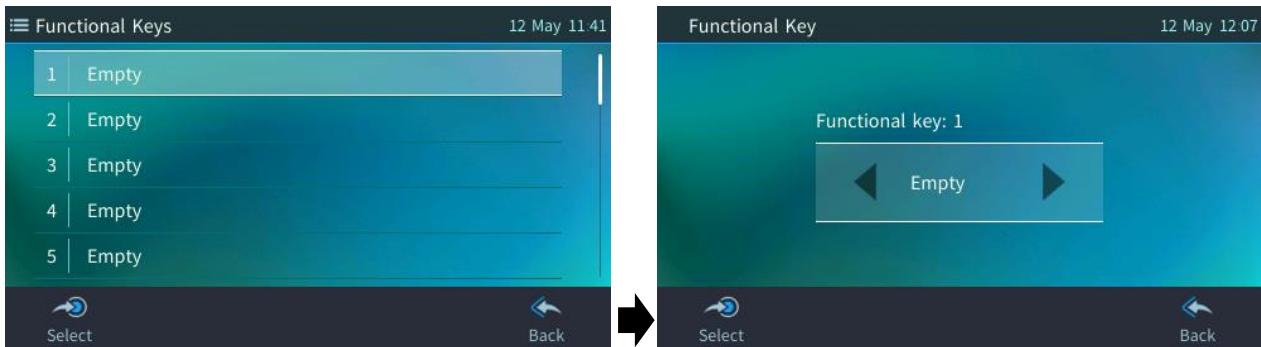

Alternatively, you can press the **MENU** hard key, press the **Keys** item; that opens the functional key settings screen.

2. Press < or > to navigate to and select **Voca** and then make sure the key is displayed in the idle screen and that it is active. If it is not active, consult your network administrator.

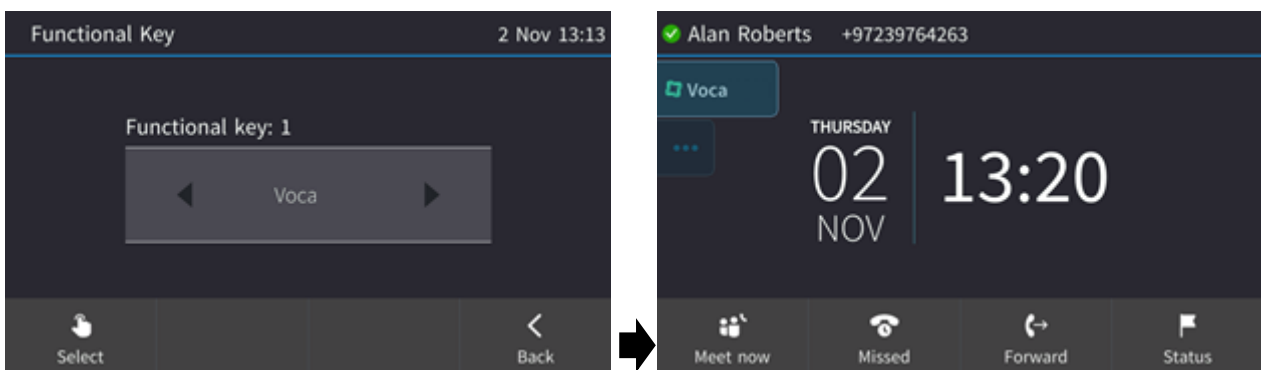

6.15 Configuring a Function/Programmable Key for Paging

Any of the Function/Programmable Keys can be configured to page a group. The feature allows live announcements to be made (paged) from a phone to a group of phones, to notify a team (for example) that a meeting is about to commence. The paged announcement is multicast via a designated group IP address, in real time, on all idle phones in the group, without requiring listeners to pick up their receivers. Listeners view the name of the group displayed on their sidecar when the paging call comes in.



The feature must be enabled in the Web interface by the network administrator before a Function/Programmable Key can be configured for paging. See the *Administrator's Manual* for more information.

To configure a Function/Programmable Key as a paging dial:

1. In the phone's idle screen, long press the Function/Programmable Key .



Alternatively, you can press the **MENU** hard key, press the **Keys** item; that opens the functional key settings screen.

2. Press < or > to navigate to and select **Paging** and then press the **Select** softkey; the Function/Programmable key #n' screen opens.

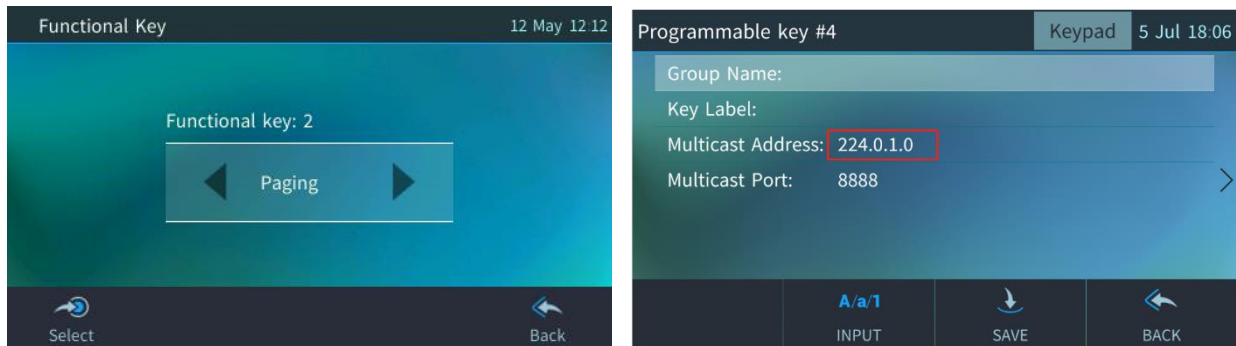

3. In the 'Group Name' field, enter the name of the group, to be displayed in the phone's screen when there's an incoming/outgoing paging call.
4. In the 'Key Label' field, configure the paging group name to be displayed in the phone's sidecar.
5. In the 'Multicast Address' field, enter the paging group's multicast IP address. Default: 224.0.1.0. For phones to be in a group, all must be configured with the identical multicast address.
6. In the 'Multicast Port' field, enter the group's port. Default: 8888. For phones to be in a group, all must be configured with the same port.
7. Press the **Save** softkey; a key is defined in the idle screen as a paging dial.

6.16 Deleting a Function/Programmable Key

A Function/Programmable Key can be deleted after you configure it if you no longer find it useful (for example).

To delete a key event:

1. In the phone's idle screen, long press the Function/Programmable Key.

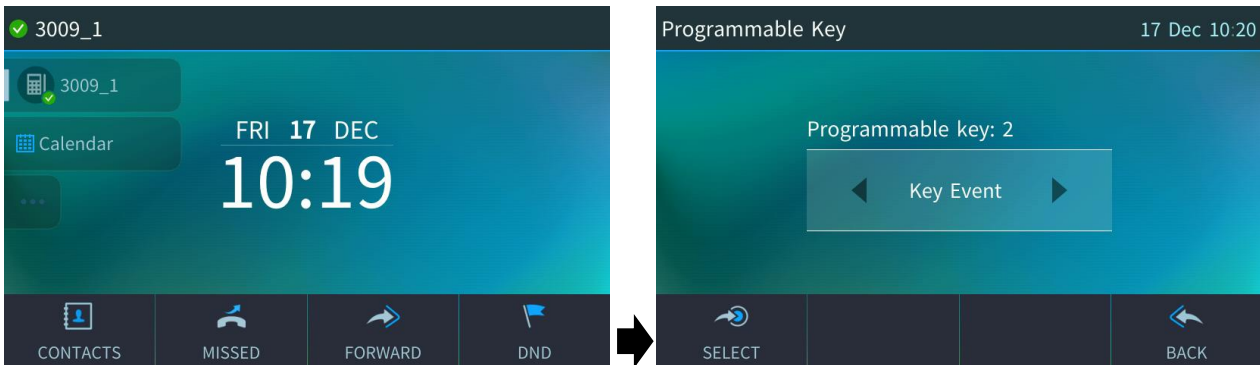

2. In the Function/Programmable Key screen that opens, navigate to and select **Empty**; the Function/Programmable Key is removed the idle screen.

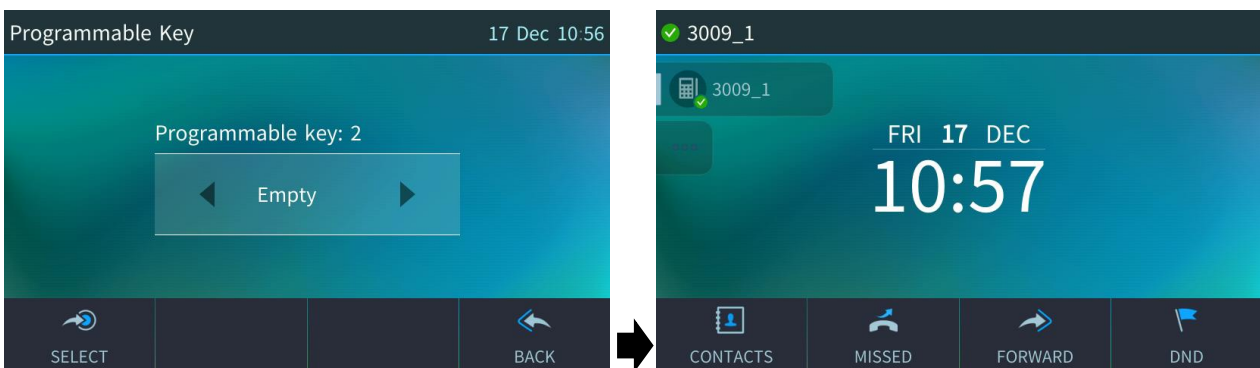

7 Performing Basic Operations

This section describes basic phone operations:

7.1 Using Audio Devices

You can use any of the following audio devices on the phone for speaking and listening:

- **Handset:** To make a call or answer a call, lift the handset off the cradle.
- **Speaker** (hands-free mode). To activate it, press the speaker key during a call or when making a call. To deactivate it, press the speaker key again.
- **Headset** (hands-free mode). When talking on the phone, you can relay audio to a connected headset. To enable it, press the headset key. To disable it, press it again.

You can easily change audio device during a call.

To change from speaker/headset to handset:

- Activate speaker/headset and pick up the handset; the speaker/headset is automatically disabled.

To change from handset to speaker/headset:

- Off-hook the handset and press the speaker/headset key to activate the speaker/headset. Return the handset to the cradle; the speaker/headset remains activated.

To change to a Bluetooth headset:



- Press the hard headset button on the phone. If for example more than one headset is connected to the phone (analog, USB and/or Bluetooth), long-press the button and in the Select Audio Device screen that opens, select USB /analog /Bluetooth.

To change to a USB headset:

- Press the hard headset button on the phone. If for example more than one headset is connected to the phone (analog, USB and/or Bluetooth), long-press the button and in the Select Audio Device screen that opens, select USB /analog /Bluetooth.

7.2 Managing Calls

The screen that is displayed after dialing provides the following information:

- The name of the calling (in the figure below it is John Kenedy)
- The number (or name) of the calling party
- Outgoing call  icon, or Incoming call  icon
- The called party's presence status (in the screen figure it's  Away, Be Right Back)
- The name of the called party (if the name is listed in the phone directory)
- The number of the called party (or contact name if listed in the phone directory)

Screen indications:

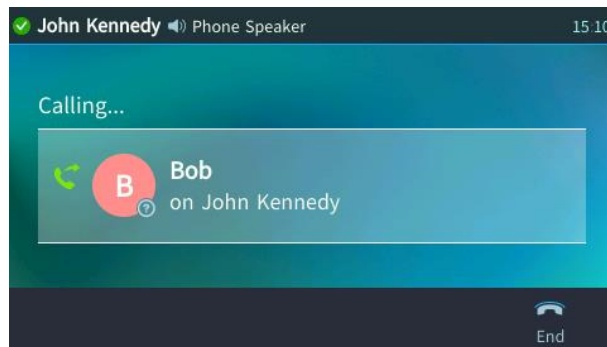

The phone plays a ring-back tone indicating to the caller that the called party's phone is ringing.

To end dialing a call before it's answered:

- Press the **End** softkey or the speaker key.



For advanced dialing using the phone directory, see Section 6.10, Managing your Personal Directory. To configure a Speed Dial, see Section 6.12, Configuring a Function/Programmable Key as a Speed Dial.

7.2.1 Dialing

This section describes dialing options:

To dial a regular-digits phone number:

1. On the keypad, key the digit of a regular phone number; the touch screen displays the digits in the New Call field.



To delete entered digits (from right to left), press the **Clear** softkey.
To cancel the call, press the **Cancel** softkey.

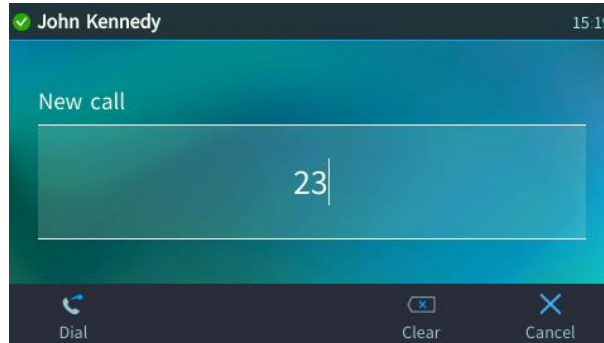

2. Do any of the following:
 - a. Don't do anything; dialing is automatically performed after a few seconds.
 - b. Press the **Dial** softkey; dialing is performed.
 - c. Pick up the receiver; dialing is performed.
 - d. Press the **Speaker** key; dialing is performed.
 - e. [If you switched on speaker/headset before keying in the number] Press the # hard key on the phone after keying in the number, to dial the number *immediately*.

To dial a URL:

1. Press the speaker key or lift the handset; the touch screen displays the New Call field and the **URL** softkey:

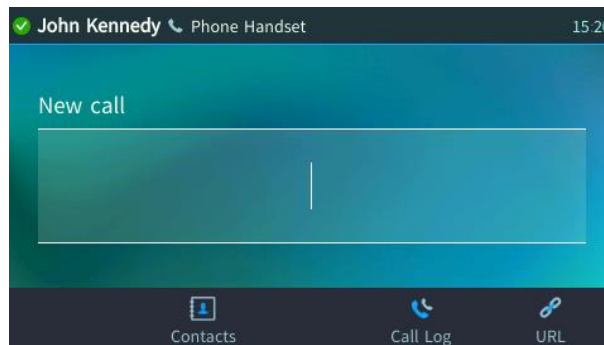

2. Press the **URL** softkey and enter a URL address.



To delete entered digits (from right to left), press the **Clear** softkey.
To cancel the call, press the **Cancel** softkey.
See Section 3.4 for how to switch letters, numerals and symbols.



3. Press the **Dial** softkey to call the URL.

7.2.2 Redialing

You can redial a number you previously dialed.

To redial:

1. Press the **REDIAL** hard key on the phone; the Dialed Calls screen is displayed, listing in chronological order, recently dialed numbers:
2. Navigate and select the phone number to redial
3. Press the **Dial** softkey or press the **OK** key.

7.2.3 Dialing a Missed Call

The phone logs all missed calls. The screen in idle state displays the number of missed calls.

To dial a missed call:

1. Press the **Missed** softkey displayed in the idle screen.
2. Select the missed call to dial.
3. Press the **Dial** softkey or press the **OK** key.



A call can be made in the same way from *any* of the Call Logs.

7.3 Answering Calls

The phone indicates an incoming call as follows:

- The screen displays incoming call icon  together with the caller's phone number (or contact name if listed in the phone directory):





- Phone rings.
- Ring LED flashes blue.

To answer:

- Pick up the handset -OR- press the headset key (make sure the headset is connected to the phone) -OR- press the speaker key -OR- press the **Accept** softkey (the speaker is automatically activated).

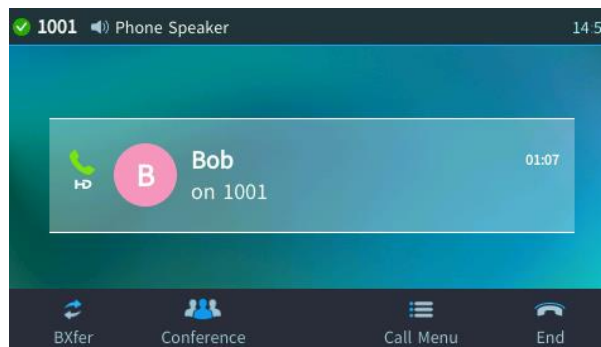
When you answer, the screen displays the  icon with the caller's details and call duration:



- **HD** in the screen indicates a high-definition call (using a wideband voice coder).
- If a contact is in a call and they are listed in your phone's Speed Dial keys, the Speed Dial key icon indicates that the contact is in a call. If that contact is in a call with another contact listed in your phone's Speed Dial keys, the Speed Dial key icons of both the calling contact and the called contact change to indicate that they are in a call.
- When two calls come in simultaneously, the names of the calling parties appear on the screen indicated by the incoming call icon . If a user is in a call and a third-party calls, the name of the calling party appears on the screen indicated by the incoming call icon .

7.4 Rejecting Incoming Calls

An incoming call can be rejected if for example you are busy or unavailable to take the call. The caller on the other side will hear a busy tone from your phone.

To reject an incoming call:

- Press the **Reject** softkey.

To send an incoming call to voicemail:

- When the phone rings to alert to a call, wait the timeout period and the call will be forwarded to voicemail.

7.5 Silencing Incoming Calls

An incoming call's ringing can be silenced if for example a colleague is consulting with you in your office and you don't want the disruption. The caller on the other side will hear regular ringing.

To silence the ringing of an incoming call:

- Press the **Silent** softkey.



- Answer a silenced call by pressing the **Accept** softkey or picking up the handset.

7.6 Making a New Call Even Though a Call is Coming in

A new call can be made even though a call is coming in, typically needed when it's more important and pressing to make a new call than to accept an incoming.

To make a new call when a call is coming in:

1. In the Incoming Call screen, tap the **New Call** softkey.
2. In the New Call screen, enter the destination number to call and then tap the **Dial** softkey.
3. When the destination number answers, you can toggle to the *calling* party and reject or accept them.

7.7 Ending an Established Call

To end an established call:

- Return the handset to the phone cradle if it was used to take the call -or- press the headset key -or- press the speaker key -or- press the **End** softkey.

7.8 Viewing the Call Log

The phone logs calls that are missed, received and dialed.

To view missed calls:

- Configure a Programmable Softkey with a 'Missed calls' key event or touch **Menu > Call Log > Missed calls**.

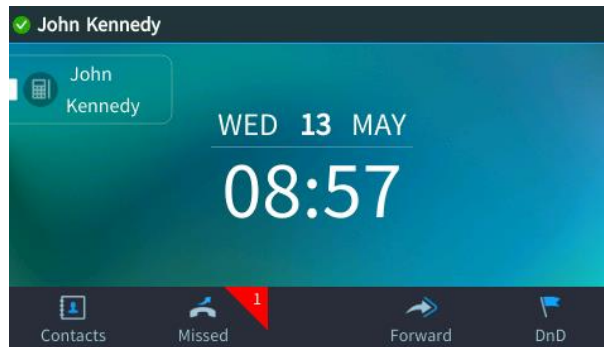

After viewing, the indication disappears from the screen. The next time a call is missed, the indication will reappear.

To view call history:

1. Open the Call Log screen (**MENU** hard key > **Call Log**).
2. In the Call Log screen, navigate to and select the call log you require.

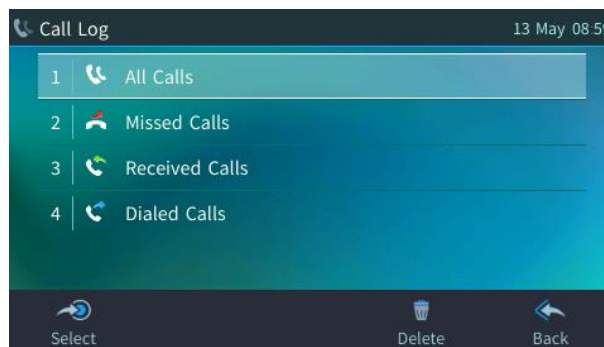

- **All Calls:** Calls that were missed, received, and dialed
 - **Missed Calls:** Calls that were not answered
 - **Received Calls:** The most recently answered calls
 - **Dialed Calls :** The most recently dialed phone numbers
3. Select the option you want (e.g., Missed Calls).
 4. Press the softkey you need:
 - **Dial:** Dials the selected logged call.
 - **Save:** Saves the selected logged call information in the Personal Directory (for adding a contact in the directory, see Section 6.10, Managing your Personal Directory).
 - **Detail:** View the select logged call details.

The Call Details screen displays the following logged call information:

- ◆ **Number:** The selected phone number logged
- ◆ **Time:** The time the call was logged
- ◆ **Date:** The date on which the call was logged

◆ **Duration** The duration of the call (if answered)



- The call history lists are stored from the newest to oldest entries. The maximum number of entries for each call history type is 20. Once this maximum is attained, the oldest entry is deleted and replaced with the new entry.
- The call history lists are saved on a daily basis. In the case of a power outage, some of the received information may be lost.
- After viewing Missed Calls (by pressing the Missed softkey), the indication in the idle screen disappears. It'll reappear the next missed call.

7.9 Using Multiple Lines

Your phone supports up to 30 lines. Each is configured with its own extension number. The figure below displays the idle screen of a phone set up with two lines whose extensions are '1002' and '1010'. The default extension line is **boldened**. In the example screen below it is **1002**.

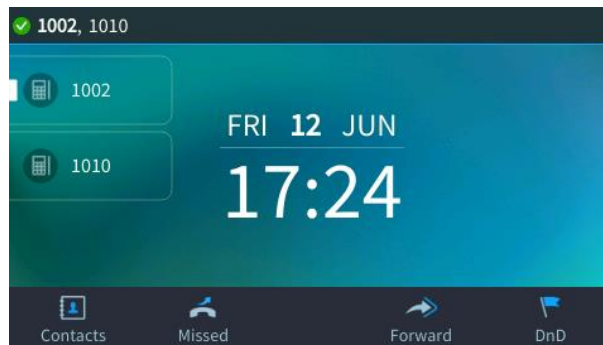

Only your phone/network administrator can configure lines. See the *Administrator's Manual* for detailed information.

7.9.1 Choosing a Line

You can select a line to use. The screen displays a bar above the extension number of the line currently being used. Until you change this line, all new calls are made on it.

To change lines:

1. Make sure that the LCD is in idle state and that no calls are established. View the two configured lines displayed in the screen. View the bar above the currently used line.
2. Navigate to and select the other line; the bar moves above it; all new calls will now be made on it.

7.9.2 Making a Call on a Line

To make a call on a line:

1. When the screen is in idle state, raise the handset or press the key of the first digit of the number to call; the NEW CALL screen is displayed.
2. Enter the number of the person to call or select a contact from the Directory and tap the **Dial** softkey; the dialed number is called and the line on which the call is made is indicated in the screen.

7.9.3 Making Two Calls on a Line

To make two calls on a line:

1. On line 1 call **A**. After establishing this call, tap the **New Call** softkey; the call with **A** is automatically put on hold and the NEW CALL screen is displayed.
2. Enter **B**'s phone number or select their entry in the directory, and tap the **Dial** softkey. **B** answers.
3. To toggle between **A** (on hold) and **B**, press the navigation control's upper and lower rim (see Section 7.9.6 on page 61).

7.9.4 Making Multiple Line Calls

Your phone supports multiple line calls. Calls can run simultaneously on each line. You can therefore have up to 12 calls running simultaneously, where one is active and 11 are on hold.

Example scenario:

1. Line 1 calls **A**
2. Line 2 calls **B**

To make a multiple line call:

1. When the screen is in idle state, navigate to and select the extension line.
2. Lift the handset; in the NEW CALL screen displayed, enter the phone number or select a contact from your directory.
3. Tap the **Dial** softkey. The called party answers.
4. Tap the **New Call** softkey; the called party is automatically put on hold and you're prompted to enter a phone number or select a contact.
5. Press the navigation control's upper or lower rim to navigate to another extension line.
6. Make another call exactly like you made the first (on hold) but on the other extension line: Enter a phone number or select a contact and tap the **Dial** softkey.
7. To toggle between the first called party who's on hold and the active called party, press the navigation control's upper and lower rim (see below).

7.9.5 Toggling Between Multiple-Line Calls

After making calls on two different lines, you can toggle between them. When using two lines, one line is active while the other is on hold. Toggling between lines therefore involves putting the currently active call on hold and resuming the previously held call.



Indicates an active line.

A call on hold is indicated like this:

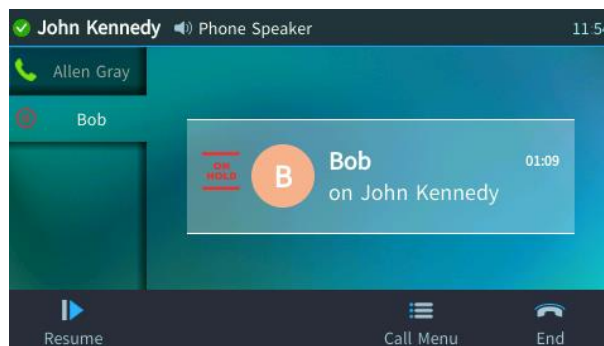

To toggle between multiple-line calls:

- Navigate to and select the conversation to resume and tap the **Resume** softkey or the **OK** hard key to resume the call.

7.9.6 Toggling Between Calls on the Same Line

You can toggle between calls on the same line. How you toggle depends on whether the first-placed call is active or the second-placed call is active.

To switch from the first-placed call to the second-placed call:

- Navigate to and select the second-placed call and then tap the **Resume** softkey; the first-placed call is automatically put on hold.

To switch from the second-placed call to the first-placed call:

- Navigate to and select the first-placed call and then tap the **Resume** softkey; the second-placed call is automatically put on hold.

7.9.7 Ending Calls

You can only end calls that are active, i.e., not on hold.

To end a call:

1. Make sure that the call is active and not on hold.
2. Tap the **End** softkey or the **SPEAKER** key.

7.10 Paging a Group

After configuring a paging group and a paging dial on the phone (see Section 6.15, Configuring a Function/Programmable Key for Paging), you can page others in your group, and they can page you, to announce a change of venue, for example. You can use the speaker, handset or headset as the audio device to page your group.

To page others in your group:

1. Press the function key or programmable key that you configured for paging the group.

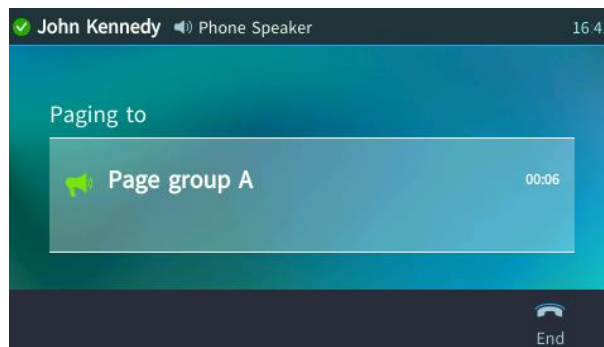

2. Pick up the receiver and make the announcement, or talk directly into the speaker.

7.10.1 Receiving an Incoming Paging Call

Any other user configured in your group can page you.

To receive a paging call from another user configured in your group:

- View in your phone's screen which group the paging call is coming from and listen to the incoming paging call.

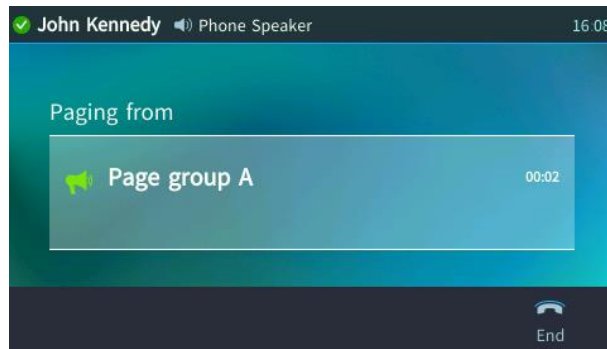

7.10.1.1 If Paged when in a Regular Call and Barge-in is Disabled

If you're in a call when paged and the 'Barge-in' feature was disabled by your network administrator, you're prompted to accept/reject the paged call.

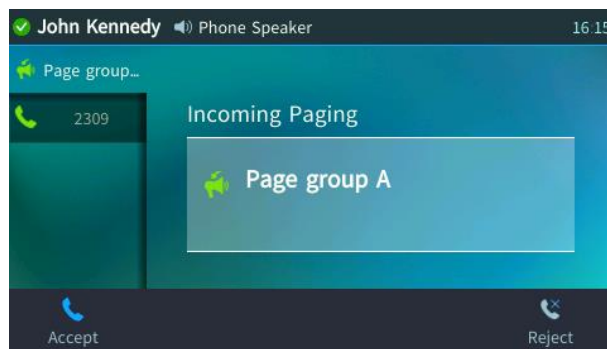

- If you tap the **Accept** softkey; the regular call is put on hold (with MoH) and the paged call is heard.

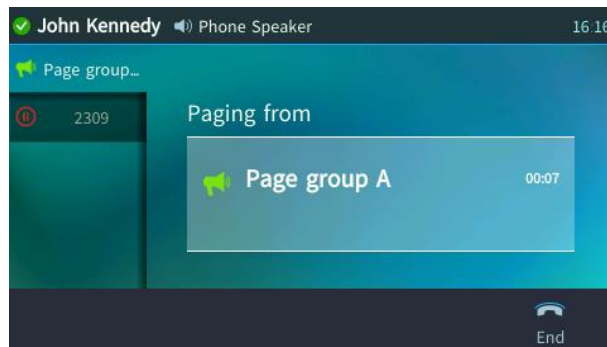

If you'd have tapped **Reject**, the paging wouldn't have barged in on the regular call.

- When you've heard the paging call, tap the **End** softkey and then the **Resume** softkey to resume the regular call that was put on hold.

7.10.1.2 If Paged when in a Regular Call and Barge-in is Enabled

If you're in a call when paged and the 'Barge-in' feature was enabled by your network administrator, the paging call barges into the regular call which is put on hold.

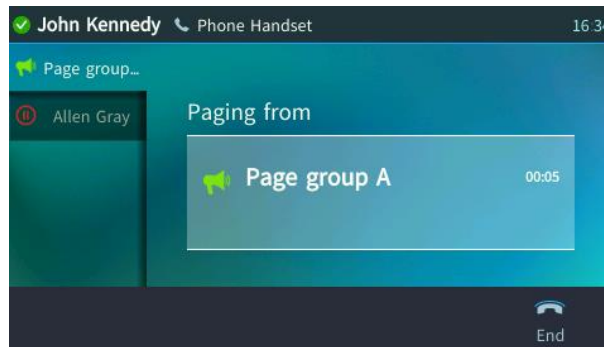

- Tap the **End** softkey and then the **Resume** softkey to resume the regular call.

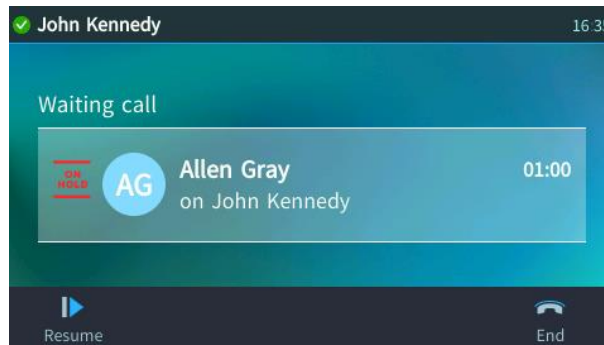

8 Performing Advanced Operations

This section describes how to perform advanced operations.

8.1 Answering Waiting Calls

You can accept a call on an extension on which there already is an active call.

To answer a waiting call:

- a. A call with Bob is in progress:



- b. A call comes in from Allen Gray:



To answer Allen Gray:

1. Press the **Accept** softkey; the waiting call from Allen Gray is answered; the previous call from Bob is put on hold:



2. To toggle between calls, press the navigation control's upper or lower rim, or press the caller's name in the screen.:



To enable / disable the call waiting feature, see Section 6.3.

8.2 Placing Calls On Hold

You can place a call on hold in order to answer an incoming call (see Section 7.1) or to make another call. The party put on hold will hear music played (Music on Hold (MOH)).

To place a call on hold:

1. Accept an incoming call.
2. Press the **HOLD** hard key; the call is put on hold.

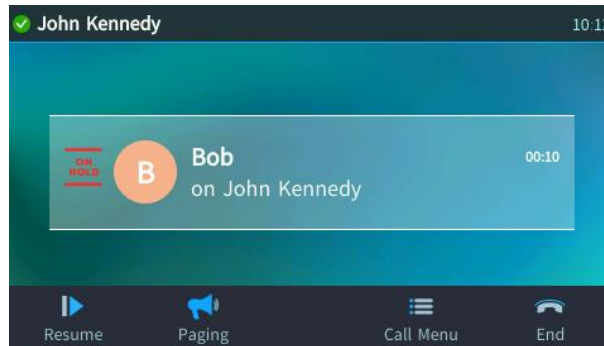

To retrieve a call on hold:

- Press the **HOLD** key again or press the **Resume** softkey.



When using the handset in a call, if the handset is on-hooked after putting the call on hold, the call is *not* disconnected and the *audio is switched to the speaker*. For the call to be *disconnected*, as it was in earlier versions, refer to your network administrator.

8.3 Calling a Contact Listed in the Directory

You can call a contact listed in your directory.

To call a contact listed in the directory:

1. Press the **CONTACTS** key and then select the directory.
2. Navigate to the contact to call.
3. Press the **Dial** softkey or the **OK** key.

8.4 Enabling Auto Redial



Support pending.

If a called party is unavailable because, for example, they're busy, the caller's phone's LCD prompts **Extension Busy. Activate auto redial on busy?**

If the caller presses the **Yes** softkey to the prompt, the busy extension is automatically redialed every *n* seconds (configurable by the caller). The caller can stop the redialing at any time.



Contact your network administrator to enable the feature if it is disabled (default).

When activated, the prompt **Dialing <ext> within <x>s** is indicated in the LCD (remote extension and timer). If activated in Multiple Line mode, **(Line <n>)** (line number) is also indicated in the LCD.

Pressing the **Dial** softkey redials the extension. Pressing the **Cancel** softkey deactivates auto-redial.



- Calls can be made and received while auto-redial is activated.
- If auto-redial is activated while another extension is called - which is also unavailable - the caller is prompted to activate auto-redial on the new (busy) extension; the previous auto-redial is then deactivated.
- If auto-redial is activated on an unavailable extension and on that same extension an incoming call is answered, the feature is deactivated.

To change the redial interval:

1. Open the 'Automatic redial' screen in the phone LCD (**MENU > Settings > Automatic Redial**).
2. Enter the interval you require and then press the **Apply** softkey.

8.5 Handling Multiple Incoming Calls

The phone is capable of handling up to eight concurrent calls per line. Multiple calls can be put on hold and you can switch between them. This feature is valuable for front desk personnel.

To manage multiple incoming calls:

- If a call comes in from Steve followed by a call from Donald, then when you answer Donald, Steve is put on hold.
- If a third call from Hilary comes in, and you answer it, Donald is also put on hold, so now both Steve (caller 1) and Donald (caller 2) are on hold.

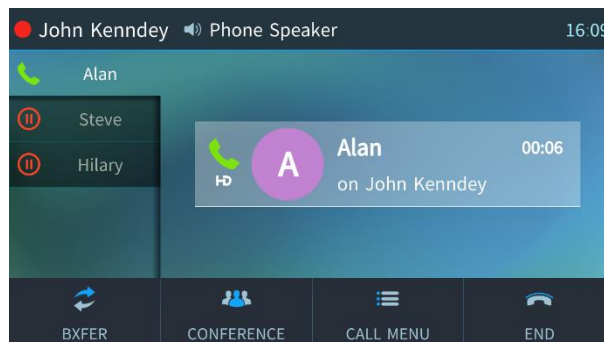

To toggle between callers:

- Press the navigation control button's upper or lower rim to navigate from one caller to another, or
- Press the caller's name in the screen.

8.6 Using a Speed Dial to Call a Contact

To quickly place a call you can press the Function/Programmable key that you configured for speed dialing.

To configure a Function/Programmable key for speed dialing, see Section 6.12, Configuring a Function/Programmable Key as a Speed Dial.

To speed dial:

- Press a function key that you configured for speed dialing.

-OR-

- Press a programmable key that you configured for speed dialing.



- Long-pressing a Function/Programmable key that is not configured for speed dialing allows you to configure one. See Section 6.12, Configuring a Function/Programmable Key as a Speed Dial.

8.7 Accessing Speed Dials when in a Call

You can access your speed dials when in a call to (for example):

- transfer the call to a third party
- add a participant to a conference

To access your speed dials when in a call:

1. When in a call, press the **BXfer** softkey (for example); the 'Blind transfer to...' screen opens displaying the **Speed Dial** softkey.

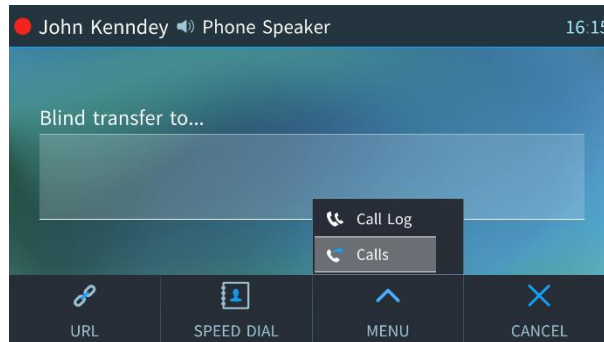

2. Press the **Speed Dial** softkey to access your speed dials.



3. In the Speed Dial screen that opens, select the Speed Dial of the contact to transfer the call to.

8.8 Transferring Calls

You can transfer a call to another party using blind transfer (default) or consultative transfer.

Transfer Method	Description
Blind	Connects another party to a third party <i>before</i> the third party answers.
Consultative	Connects another party to a third party <i>after</i> the third party answers and agrees to take the call from the second party.



- The hard TRANSFER key on the phone *by default* performs a *blind transfer*.
- Your network administrator can change the key's default functionality to *consultative transfer* (see the *Administrator's Manual* for more information).

8.8.1 Performing a Blind Transfer

A second party can be transferred to a third party before the third party answers, without consulting with them.

To perform a blind transfer:

1. Bob Smith asks you – John Kennedy - to transfer him to Allen Gray. Press the TRANSFER key on the phone or press the **Call Menu** softkey > **Blind transfer**. Bob is put on hold.

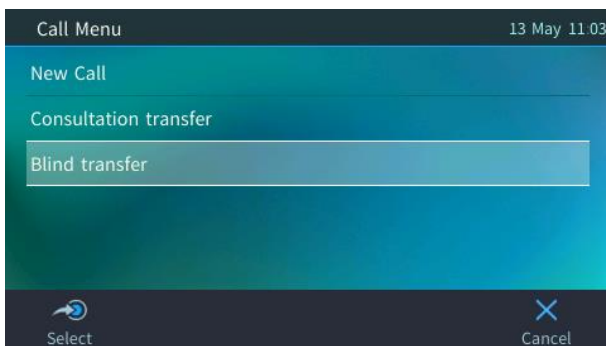

2. Enter Allen Gray's number (2309) and then select **Transfer**.

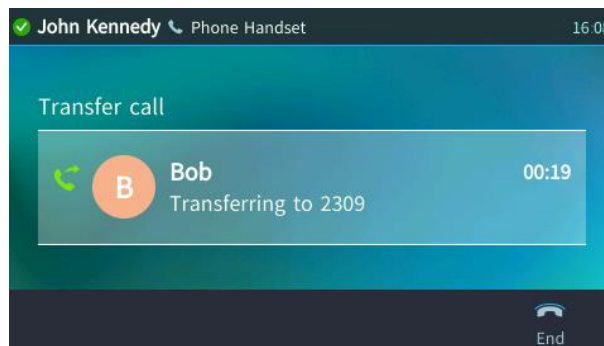

3. On the other side, Allen Gray's phone (2309) rings. Your phone - John - is immediately disconnected from Bob Smith who is transferred to Allen Gray.

8.8.2 Performing a Consultative Transfer

You can consult with a third party before transferring a second party to the third party. This consultation (semi-attended) transfer can be performed using the **Trans.** softkey or the TRANSFER key on the phone.



The **Trans.** softkey is not available by default on the phone and must be configured in the configuration file. For more information, see the *Administrator's Manual*.

To perform a consultation transfer:

1. In a call with Bob Smith, he asks you (John Kennedy) to transfer him to Allen Gray. Press the **Call Menu** softkey and then select **Consultation transfer**.

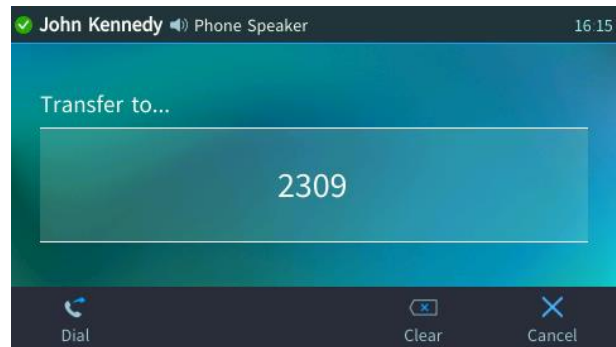
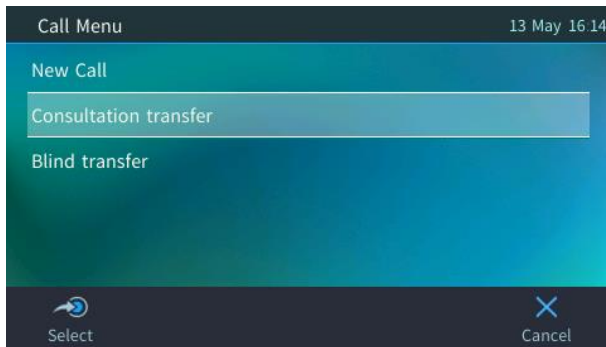

2. Enter Allen Gray's number (2309)
3. Press the **Dial** softkey.
Allen Gray's phone rings and he answers.

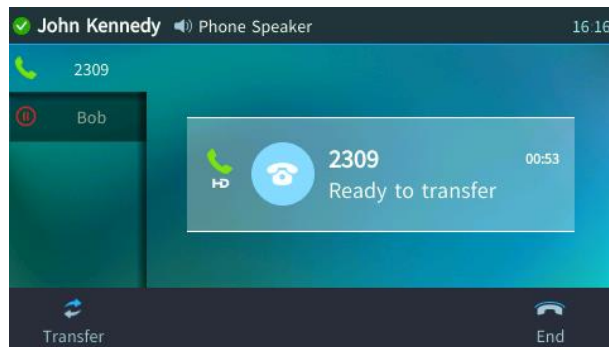

4. Consult with Allen Gray. Ask him for example if he is willing to take the call from Bob Smith. If he is agreeable, press the **Transfer** softkey or press the **TRANSFER** hard key; Allen Gray is connected to Bob Smith and you (John Kennedy) are disconnected.

8.8.3 Transferring a Call to a Remote Party on Hold

This feature allows you to transfer a call to another person with whom a call has been established, by selecting the call from a list of calls. You can consult with any person with whom a call has been established, without needing to use the Consultation Transfer procedure.

To activate the feature:

1. Press the **BXfer** softkey and then press the **Menu** softkey and select **Calls**.

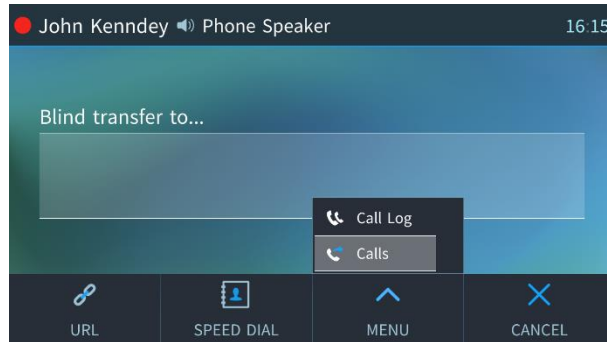

2. Select the active call; the call is then transferred to the remote party with whom that call was established.

8.8.4 Merging Calls into a Conference Call

When in a call, you can add another participant and then merge all into a conference call. Merging is therefore similar to adding a participant to a conference. It can be performed on the phone softkey or through the Skype for Business client if the user is paired.



A regular call cannot be merged with an active conference call.

To merge calls:

1. When in a call with Bob Smith, you (John Kennedy) decide you want to add Allen Gray to the call. Press the **Call Menu** softkey, select **New Call**, enter Allen Gray's number and then press the **Dial** softkey; Bob Smith is put on hold. Allen Gray answers.
2. Press the **Call Menu** softkey; Steve is put on hold and the Call Menu screen is displayed.

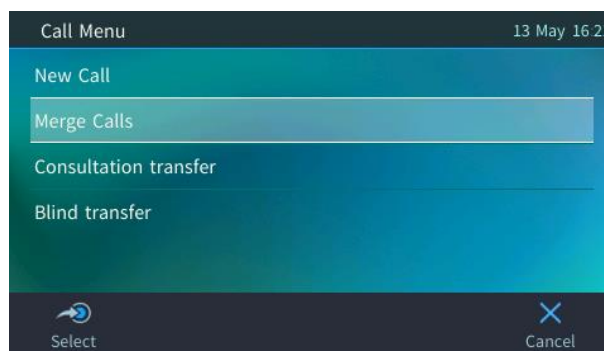

2. View your call with Bob Smith merged with the newly made call with Allen Gray (2309).

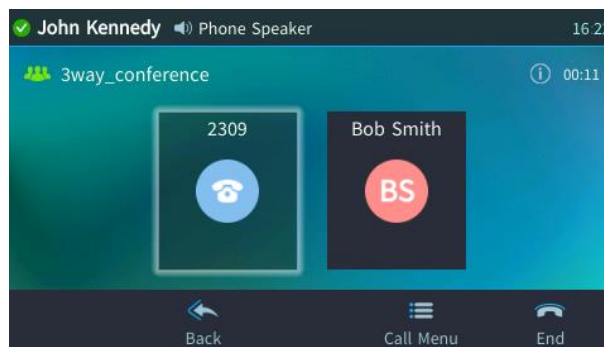

3. When Allen Gray answers, press the **Call Menu** softkey and then select **Merge Calls**; all three of you are now in the conversation.

8.8.5 Merging a Call with a Call on Hold

This feature lets you merge a call with an existing (active) call.

To activate the feature:

- Press the **Call Menu** softkey, select **Merge calls** and then select the preferred option.

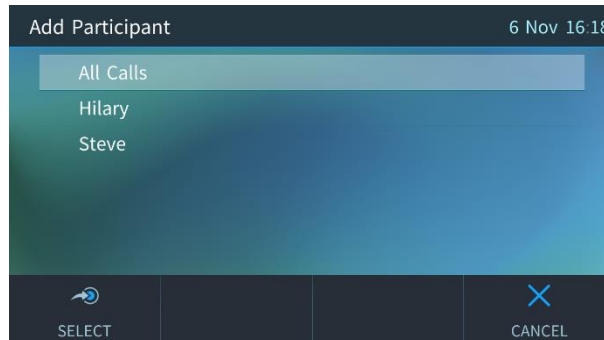

8.8.6 Leaving a 3-Way Conference You Set up without Disconnecting the Others

A caller who sets up a three-way conference call with two other parties can leave it without disconnecting the two other parties. The two others continue uninterrupted. The 'Drop from Conference' feature supports this capability.

To leave a conference you set up, without disconnecting the other parties:

- On-hook to end the call or press the **End** softkey; you're disconnected from the conference; the two remaining parties continue unaffected.



The initiator of a call conference can also drop out of the conference by on-hooking the phone, without disrupting parties B and C. In a conference call initiated by user A with participants B and C, user A can on-hook to drop out, and B and C can continue talking uninterrupted. Previously, only a softkey option was available for dropping out. A new enable parameter commands the new SIP behavior (a 'Refer' is sent when user A on-hooks).

8.9 Activating Do Not Disturb

The Do Not Disturb (DnD) feature stops the phone from ringing if anyone calls. If DnD is activated and someone calls:

- The caller hears a tone indicating that your phone is busy.
- The call is blocked and the idle screen indicates 'Missed Calls'.

To activate DnD:

1. Make sure your phone is in idle state and that the idle screen is displayed, i.e., that you're not in an active call or dialing a number.
2. Press the **DnD** softkey:

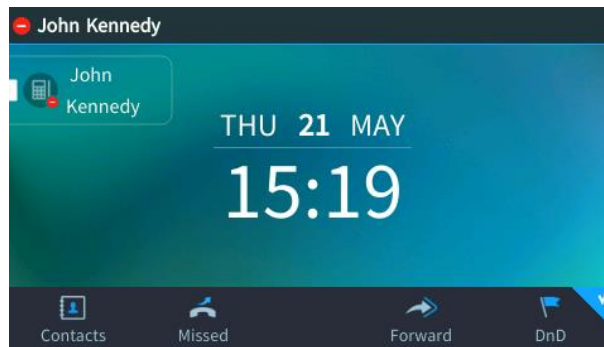

The screen displays a red 'no entry' icon adjacent to the extension line indicating that incoming calls are blocked, as well as a tick symbol next to the **DnD** softkey, as shown in the figure above.



- If DnD is activated on all line extensions, the tick symbol is colored *light blue*.
- If DnD is activated on only some of the line extensions, the tick symbol is colored *gray*.

To activate DnD on multiple line extensions:

1. Make sure your phone is in idle state and that the idle screen is displayed, i.e., that you're not in an active call or dialing a number.
2. Press the **DnD** softkey:

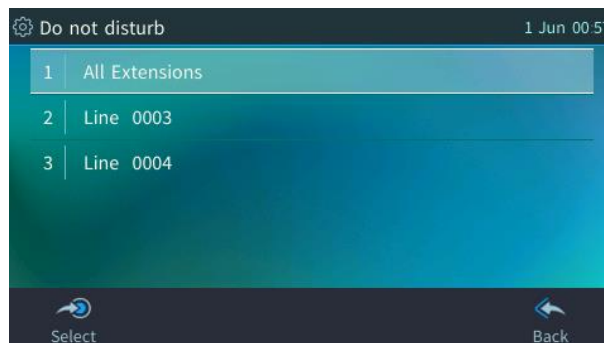

3. Select All Extensions to activate the feature on all line extensions or navigate to and select the extensions on which to activate DnD and then **Save**.

To deactivate DnD:

1. Make sure that the phone is in idle state and that the idle screen is displayed, i.e., that you're not in a call or dialing a number.

2. Press the **DnD** softkey; the 'no entry' icon is no longer displayed on the screen and your phone will now ring for incoming calls.



[Support pending] If your enterprise deployed a BroadSoft server, your network administrator can control the DnD on the phone from the BroadSoft server.

8.10 Retrieving Voice Mail Messages

Voicemail is indicated *per line* in the phone's idle screen when the phone is in a multi-line configuration. You can determine if new messages are in your Voice Mail if:

- The Ring LED on the front of the phone is permanently lit blue.
- A stutter dial tone is heard when you pick up the handset.
- The Voice Mail key is lit red.

To listen to Voice Mail messages:

1. Press the Voice Mail key on the phone (it'll be illuminated red if there's voicemail); you're prompted to enter the Voice Mail number.

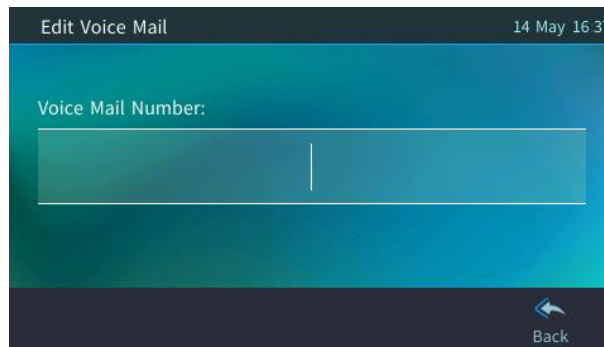

The preceding screen will only be displayed if your network administrator did not configure the Voice Mail server number.

2. Enter the Voice Mail number (get it from your network administrator) and press the **Save** softkey.
3. Press the Voice Mail key again; the phone dials your enterprise's Voice Mail box; the phone establishes the call with the server.
4. Enter DTMF to pass server authentication and then listen to your voice mail.

8.11 Parking a Call

A call can be transferred to a "parking lot" where it can be picked up on any other phone in the enterprise by a party who dials a retrieval number to retrieve it. The retrieval number is configured in the server's parking lot parameter by the network administrator.



Tip: Don't park a call unless you know precisely who you want to answer it. If you park a call, it can be answered by anyone in the enterprise listed in the server's parking lot parameter.

To configure a Functional Key for parking a call:

1. Long-press any of the unconfigured buttons adjacent to the sidecar fields.
2. Press the right rim of the navigation key button to navigate to and select **Parking Lot**.

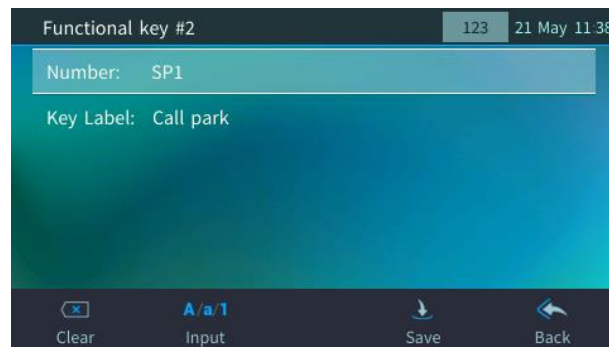
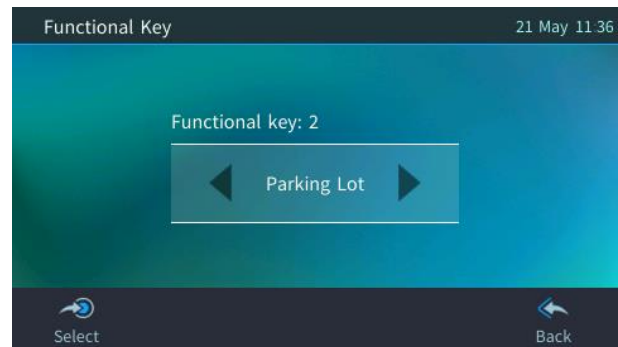
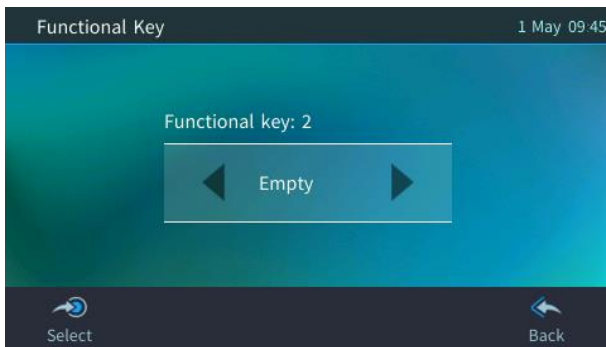

3. Obtain the 'Number' from your network administrator and enter it in the 'Number' field.
4. Enter an intuitive 'Key Label' for enhanced usability, for example, **Call park**, and press **Save**.

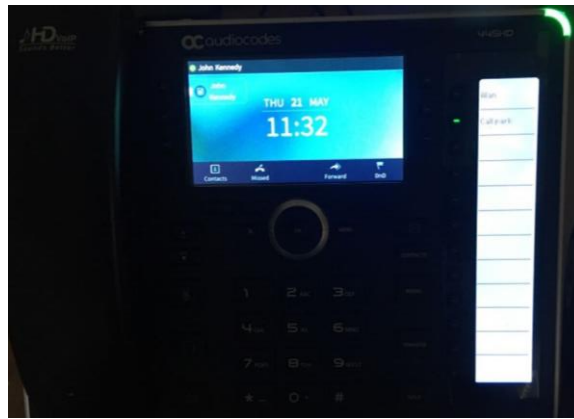

To use the feature:

- When you are in a call, press the configured button adjacent to the sidecar field. Go to the other phone on which you want to pick up the parked call. Pick it up on that phone.

8.12 BLF Call Pickup

This feature allows you to 'pick up' on your phone a call that comes in on another employee's phone but that employee is OOO (for example).

After configuring a speed dial for an employee, when a call comes in on that employee's phone the sidecar's BLF button next to the speed dial *on your phone* flashes green, allowing you to 'pick up' the call by pressing the BLF button.



Before using this feature, make sure your network administrator has enabled it on the server.

8.13 Managing a Conference

Users can manage a three-way call conference, based on SIP, from the phone. This supported conference capability is *locally* based (phone based), i.e., the initiator of the conference call adds participants.

To start a conference:

1. In the phone's idle screen, make a call and press **Conference**.

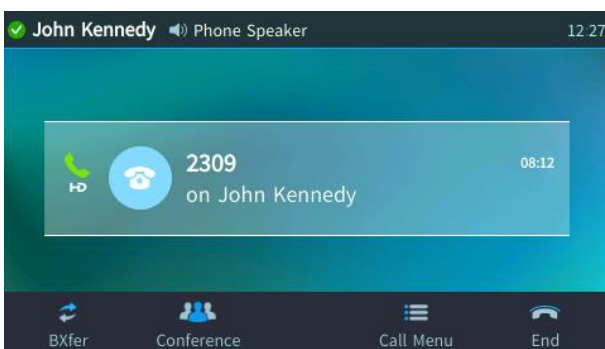

2. In the Add Participant screen that opens, enter the participant's phone number and press the now activated **Dial** softkey.

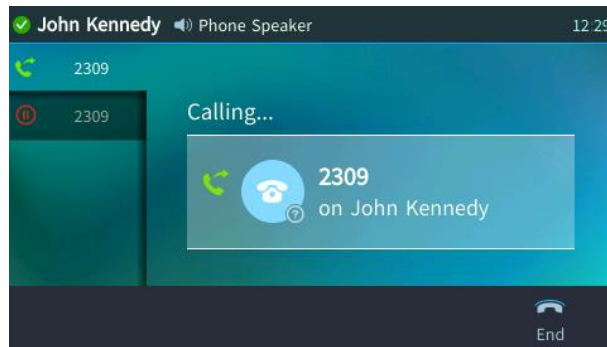

- When the call is established, press the **Conference** softkey, enter the next participant to add to the conference and then press the now activated **Dial** softkey.

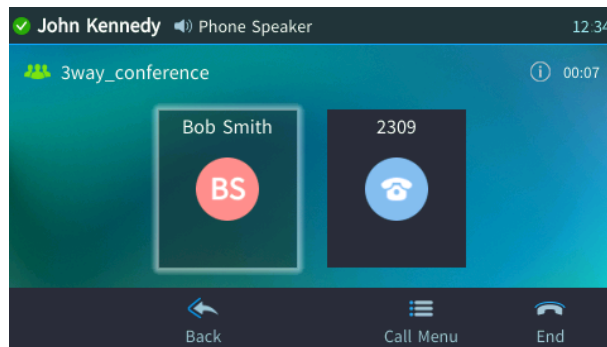

To view conference information:

- In the Conference screen, press the Call Menu softkey and then select **Conference Info**.

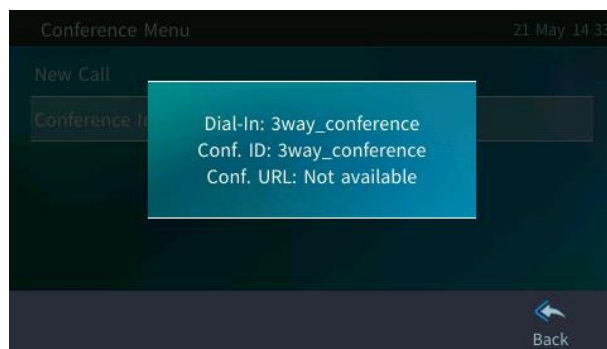

8.14 Muting the Microphone

During a call, you can mute the microphone of the handset, headset, or speaker so that the other party cannot hear you. While the call is muted you can still hear the other party. Muting calls can also be used during conference calls.

To mute/unmute:

- During a call, press the mute key on the phone 
- To unmute, press the mute key again and resume the conversation.

8.15 Paging

This feature allows live announcements to be made (paged) from a phone to a group of phones, to notify a team (for example) that a meeting is about to commence at a certain venue. The paged announcement is multicast via a designated group IP address, in real time, on all idle phones in the group, without requiring listeners to pick up their receivers. The name of the group is displayed on phone screen when the paging call comes in.



- For detailed information on configuring a Function/Programmable Key for paging on the phone, see Section 5.20.
- The feature must be enabled in the Web interface by the network administrator before a Function/Programmable Key can be configured for paging. See the *Administrator's Manual* for more information.

8.15.1 Barge-in



The feature must be enabled in the Web interface by the network administrator for it to Function/Programmable. See the *Administrator's Manual* for more information.

If the feature is enabled, paging calls will interrupt (barge in on) phone conversations that are in progress, without prompting you in the phone's screen with an option to accept or reject the paging call.

If disabled (default) and a paging call comes in, you'll be prompted in the phone's screen to choose whether or not to accept or reject the paging call. If you accept, the paging call is heard and the regular call is not.

8.15.2 Performing a Paging Call

The phone speaker, handset or headset can be used as the audio device to page others in your group.

To page others in your group:

1. Press the Function Key displayed in the idle screen that you configured for paging a group – 'Morgages' in the figure below.

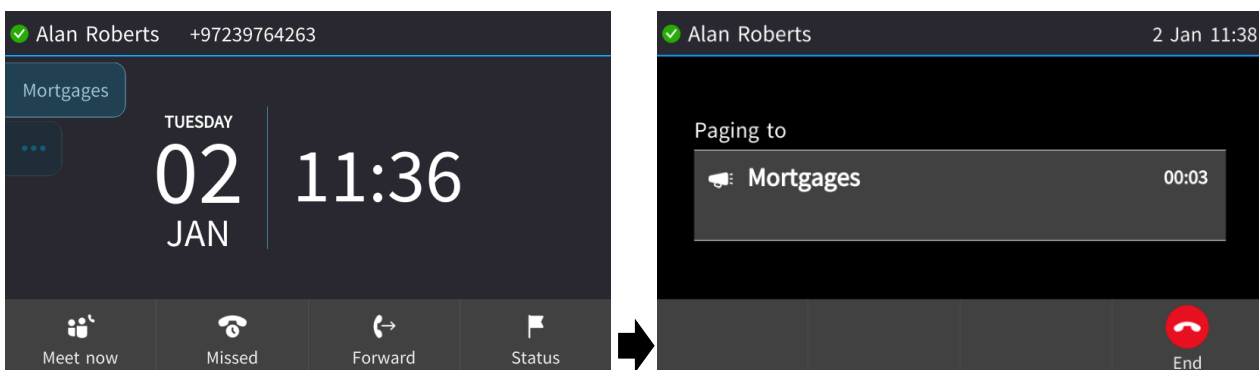

2. Pick up the receiver or talk directly into the speaker or headset to make the announcement.

8.15.3 Receiving an Incoming Paging Call

Others in your group can page you.

To receive a paging call from another in your group:

1. View in your phone's screen which group is paging you and listen for the announcement.

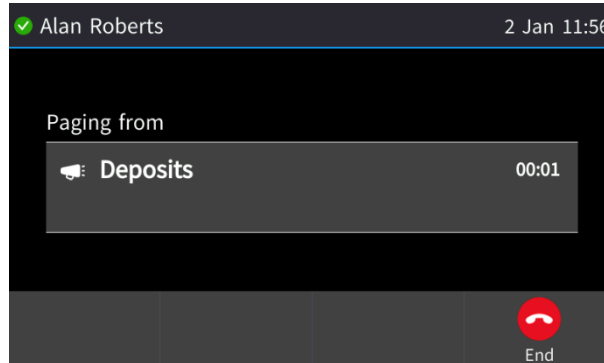

If you're *in a regular call* when the paging call comes in and the 'Barge-in' feature was *enabled* by your network administrator, the paging call barges in on the regular call.

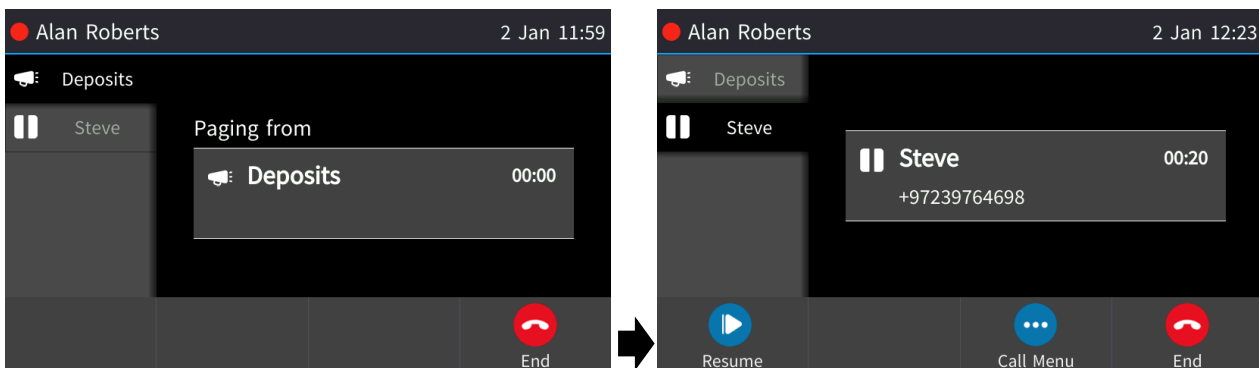

2. Optionally, navigate to the caller whom you were speaking with before the barge-in and then press the **Resume** softkey to resume the conversation with them.



If you're *in a regular call* when there's an incoming paging call and the 'Barge-in' feature was *disabled* by your network administrator, you're prompted to *accept* or *reject* the incoming paging call.

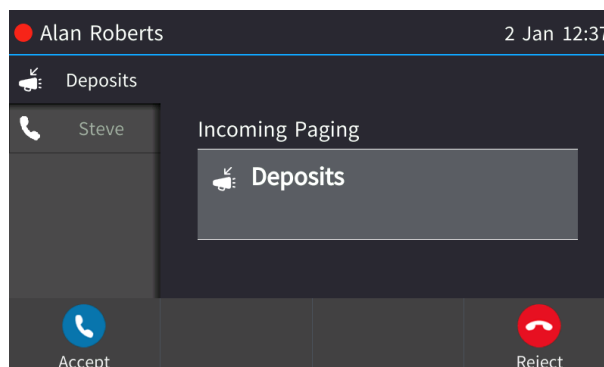

3. If you press the **Accept** softkey, the incoming paging call is heard and the regular call is not.

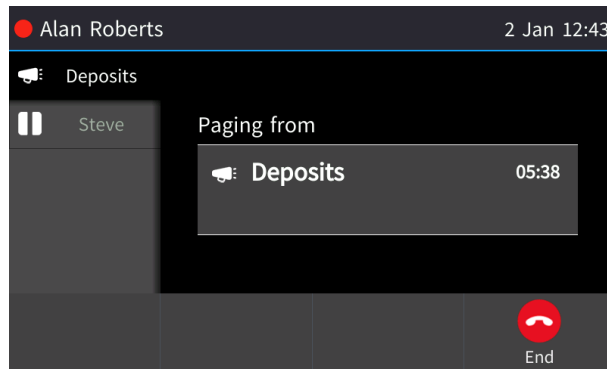

4. If you then press the **End** softkey, the paging call is terminated and you're given the option to **Resume** the regular call.

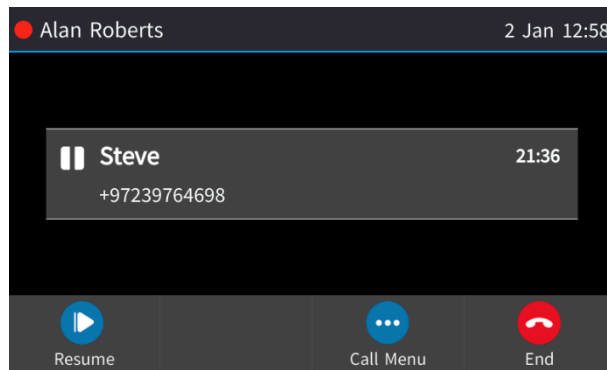

If you pressed the **Reject** softkey when the paging call came in, it would have been rejected (not heard) and the regular call would have continued.

8.16 Configuring Bluetooth on the Phone

The phones support integrated Bluetooth for (wireless) USB headset connectivity.



- Beta level
- Only applies to the 445HD-BW model.
- Supported in specific regions such as the USA, Canada, the European Union, Switzerland, South Africa and Israel, and requires a specific CPN with a 'BW' suffix when ordering. For an updated list of supported regions, contact AudioCodes.

To enable Bluetooth on the phone:

1. Access the Bluetooth screen (**Menu > Settings**):

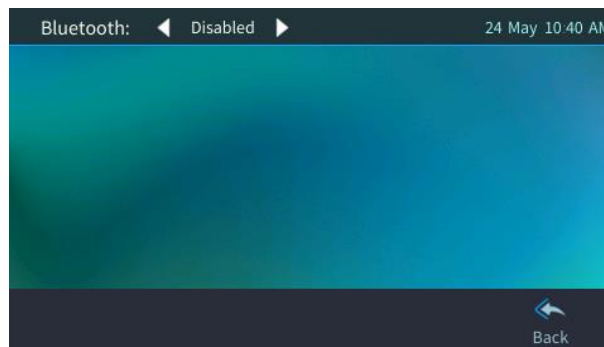

2. Press the right/left rim of the navigator key to configure **Enabled**:

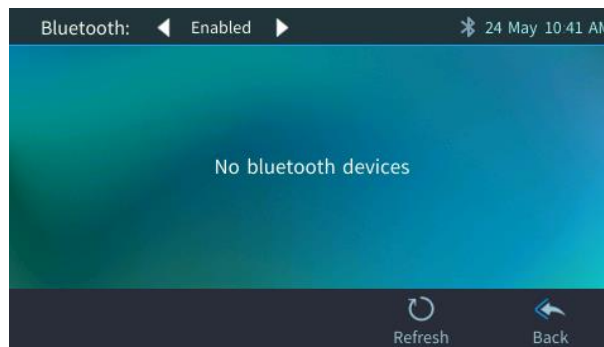

3. Configure the device (Bluetooth headset or speaker) to allow pairing and then press the **Refresh** softkey; the phone attempts to discover available devices:

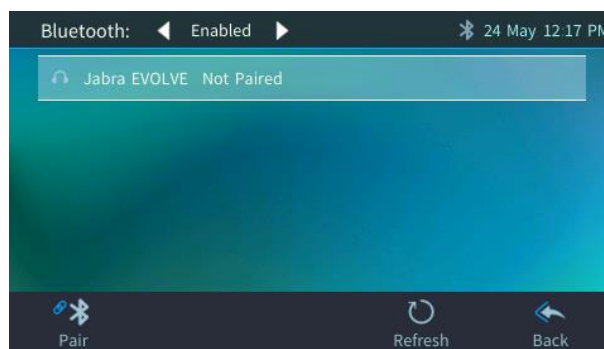

4. Press the **Pair** softkey to pair the device. After pairing is complete, the phone displays 'Connected'.

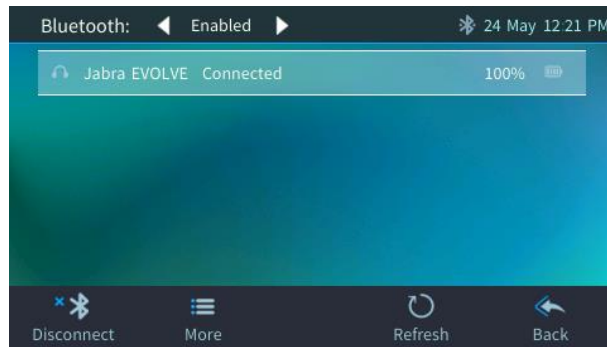

When the phone is connected via Bluetooth, its battery level is visually indicated adjacent to the 'Connected' indication. Bluetooth connectivity is indicated on the upper bar by the Bluetooth icon.



indicates Bluetooth is enabled, not paired.



indicates that the device is connected.

5. Start using the device.

- The following Bluetooth call controls are supported (and can be used from the Bluetooth device itself):
 - ◆ Accept call
 - ◆ End call
 - ◆ Reject call
 - ◆ Mute/unmute
 - ◆ Volume up/down



- All Bluetooth headsets are defined by the phone as headsets and the phone's headset hard key onhooks / offhooks the headset.
- Connecting both the USB headset and the Bluetooth headset is currently not recommended.
- Known speakers such as the HRS 457, Jabra 710 and Jabra 510 are not defined as Bluetooth headsets. Users can define a known Bluetooth speaker as the phone's default Audio Device from **Settings > Audio Device**:

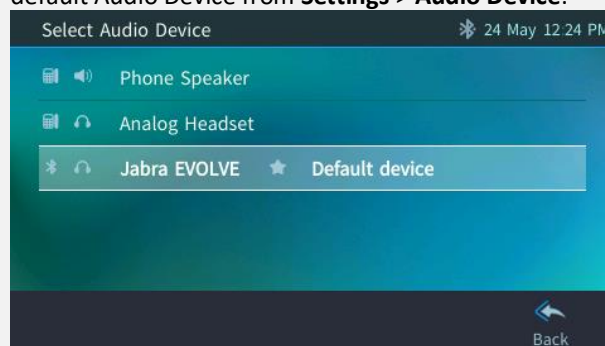

- After it is selected, the Bluetooth speaker will be used whenever a call is answered via the **Accept** softkey or initiated via the **Dial** key. The phone's hard speaker and headset keys are used for its speaker and connected headset, for example, USB headset.

9 Troubleshooting

Read this section if a problem with a phone occurs. Contact your administrator if necessary.

Table 8-1: Troubleshooting

Symptom	Problem	Corrective Procedure
Phone is off (no screen displays and LEDs)	Phone is not receiving power	<ul style="list-style-type: none"> ■ Verify that the AC/DC power adapter is attached firmly to the DC input on the rear of the phone. ■ Verify that the AC/DC power adapter is plugged into the electrical outlet. ■ Verify that the electrical outlet is functional. ■ If using Power over Ethernet (PoE), contact your network administrator to check that the switch is powering the phone.
'LAN Link Failure' message displayed in the screen	No LAN connection	<ul style="list-style-type: none"> ■ Verify that the LAN cable is connected securely to the LAN port on the rear of the phone. ■ Verify that the other end of the LAN cable is connected to the network (switch). If it's not, inform your network administrator.
Phone is not ringing	Ring volume is set too low	<ul style="list-style-type: none"> ■ Increase the volume (see Section 5.13.1)
Screen display is poor	Screen settings	<ul style="list-style-type: none"> ■ Adjust the phone's screen brightness (see Section 5.8)
Headset has no audio	Headset not connected properly	<ul style="list-style-type: none"> ■ Verify that your headset is securely plugged into the headset port located on the side of the phone. ■ Verify that the headset volume level is adjusted adequately (see Section 5.13.5).
 displayed in the idle screen	Can't connect to Exchange	<ul style="list-style-type: none"> ■ Change the username format from audiocodes/someone to someone@audiocodes.com to sign in to the phone.

A Specific Third-Party Features



Support pending.

This appendix describes phone features that are only applicable to specific third parties.

A.1 Ribbon Communications Genband SLA

The following Kandy Business Solutions (KBS) softswitch solution features can be configured:

- Shared Line Appearance (SLA)
- Call pickup
- Busy Lamp Fields (BLFs)

A.1.1 Configuring Shared Line Appearance

When a call comes in on a shared line, all phones ring in the SLA group. When answered by someone in the group, all other users in the group can see there's an active call on the line. When there's an active call on the line, no other phone can initiate a call on the line. When a call is put on hold, the caller hears music; other users in the group can see the call is on hold (color indication or flashing). When a call is on hold, the same phone or another phone can retrieve the call. Full documentation on this feature is pending.

A.1.2 Configuring a Call Pickup Group

When configuring a call pickup group, basic configuration options determine:

- the numbers that route into a call pickup group
- whether or not vertical service code (VSC) dialing can be used by group members
- group members

Advanced configuration options allow you to specify:

- the maximum number of group members
- the maximum number of call queues
- whether or not SIP dialog event package subscriptions are enabled

Full documentation on this feature is pending.

A.1.3 Configuring BLFs

Full documentation on this feature is pending.

A.2 BroadSoft

A.2.1 Shared Call Appearance

The SCA feature enables multiple phones to be associated in an SCA group so that calls can be made or received on any phone in the group.



- For detailed information on how to configure the SCA feature, see the *Administrator's Manual*.
- Icons in the phone's screen indicate if line keys are configured in an SCA group, or as private lines.
- A hollow icon ☒ indicates a phone configured in an SCA group.
- A solid icon ☑ indicates a phone configured as private.

If a call comes in to a phone in the SCA group, all phones in the group ring simultaneously. The first to answer is connected to the caller. All other phones then stop ringing. The recipient can then opt to put the call on hold. All calls put on hold and all active calls are displayed in all phones' sidecars. An SCA group user can pick up a call by pressing their sidecar BLF LED.

Figure A-1: SCA



To make a call, answer a call, put a call on hold, forward a call, etc., is the same as for private phones, but LEDs indicate that a phone is in an SCA group. The table below shows LED behaviors on the phones in an SCA group.

Table A-1: LED Behaviors on an IP Phone in an SCA Group

State	Phone	LED Behavior
When the phone is in idle state	No LED indications on any phones	No behavior
When a phone is seized (off hooked)	Off hooked phone	Solid green (for a 15 second default timeout)
	Other phones in the group	Solid red (for a 15 second default timeout)
When an outgoing call is progressing	Calling phone	Solid green
	Other phones in the group	Solid red
When a call comes in	All phones	Fast flashing green
When a phone is busy (active)	Active phone	Solid green
	Other phones in the group	Solid red
When a phone is put on hold	Phone on hold	Slow flashing green
	Other phones in the group	Slow flashing red

A.2.1.1 Demonstrating the SCA Feature's Capabilities

This section demonstrates the SCA feature's capabilities.

Figure A-2 below shows two 440HD phones in an SCA group, whose numbers end in suffixes **1** and **2**.

Figure A-2: Two 440HD Phones in the SCA Group

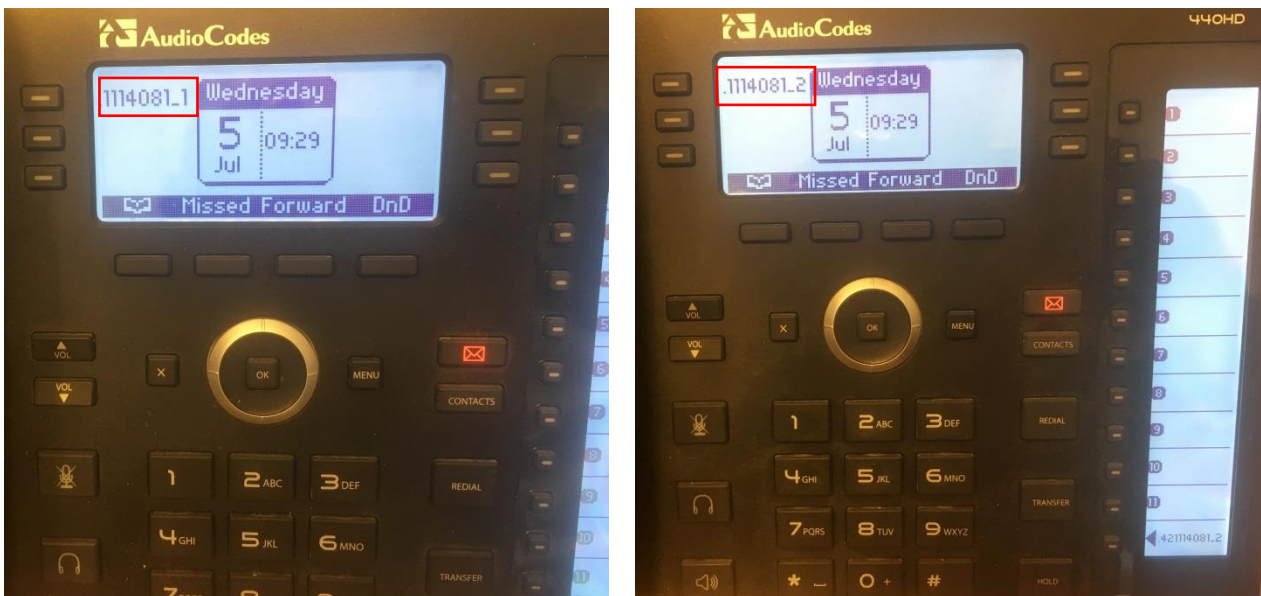
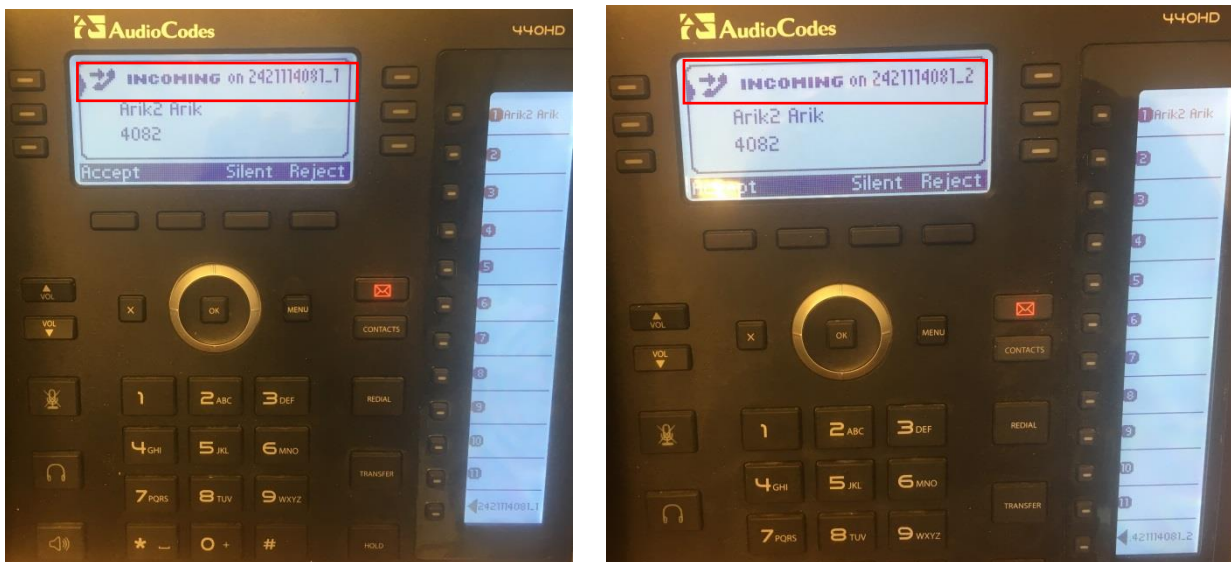

Figure A-3 below shows an incoming call from Arik. Both phones in the SCA group ring in order to alert group members to the call.

Figure A-3: Phones in the SCA Group Ring, Alerting to an Incoming Call



Phone 1 answers:

Figure A-4: Phone 1 after Answering the Incoming Call

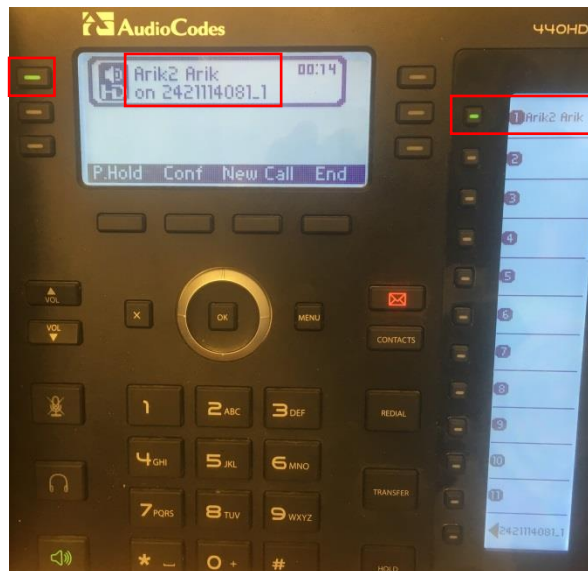

In the figure above:

- Phone 1's line key LED is illuminated *steady green*.
- Phone 1's sidecar displays the call from Arik - the adjacent BLF LED is illuminated *steady green*.
- The sidecar displays all active calls in the SCA group.
- If phone 1 puts the call from Arik *on hold*, the line key LED and the sidecar's BLF LED *flash green*.

Figure A-5 below shows phone 2 after phone 1 answers.

Figure A-5: Phone 2 after Phone 1 Answers

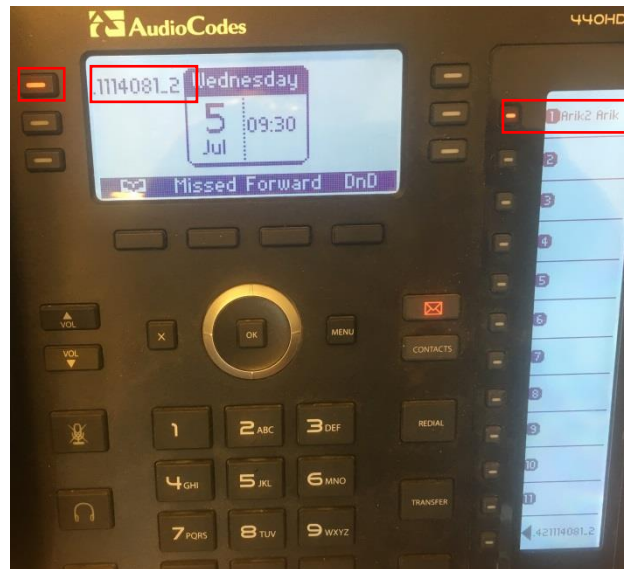

In the figure above:

- Phone 2's line key LED is illuminated *steady red*.
 - Phone 2's sidecar displays the call from Arik that was answered by phone 1. The adjacent BLF LED is also illuminated *steady red*.
 - All active calls in the group are displayed in the sidecar.
- Phone 2 can *barge in* on the call by pressing the sidecar BLF LED illuminated steady red.
 - If phone 1 puts the call from Arik on hold, the line key LED and the sidecar's BLF LED on phone 2 *flash red*.
 - Phone 2 can then press the sidecar's BLF LED flashing red, and pick up the call.

A.2.2 Monitored Lines Based on BroadSoft's BroadWorks BLF Service

This section shows how to configure Monitored Lines based on the BroadWorks BLF service, typically used by executive assistants or front desk operators to monitor lines in the network.



- The feature can also be configured by the network administrator. See the *Administrator's Guide* for detailed information.
- Before configuring monitored lines, your network administrator must enable the BLF service feature in BroadSoft's BroadWorks server. See the *Administrator's Guide* for detailed information.

To configure a monitored line:

1. On the device, long-press a Programmable Key or a Function Key, and in the Line Key / Function Key screen that opens (respectively), navigate to and select **Speed Dial + BLF**; the Line Key or Function Key screen (respectively) opens.
2. Enter the telephone number to assign the speed dial to. For Function Keys you can select the number from the Directory.
3. Navigate to enter a label (Programmable Key only), and then press the **Save** softkey.
4. View the line number displayed in the LCD's idle screen / BLF (440HD only).

A.2.3 Using Xsi Interface Services

If phones are configured to access BroadSoft's BroadWorks server's Xsi interface using HTTP/S authentication, BroadSoft environment users can enter their BroadWorks user credentials for Xsi access and then benefit from the following three supported Xsi services:

A.2.3.1 Call Center List

Your network administrator can assign you up to three call centers that will be displayed on the right side of your phone screen.

The screen displays three call centers, for example: Dept. B, Dept. C and Dept. A, configured on programmable keys 4-6. You can enable | disable each by pressing its programmable key.

The feature allows enterprise front desk personnel to indicate their availability status (available or unavailable), in each call center, to the BroadWorks server. The server then efficiently distributes incoming calls to front desk personnel, saving callers from the inconvenience of unanswered referrals or disconnections.

A.2.3.2 Contact Synchronization

Contact directories are pulled directly from the BroadWorks server. Case-insensitive Abc name search is performed instantly. Supported directories are Group Directory, Enterprise Directory, Group Common, Enterprise Common and Personal Directory. The feature cannot coexist with contacts saved locally on the phone.

A.2.3.3 Call Log Synchronization

Call Logs are pulled directly from the BroadWorks server. The phone displays the following Call Logs: All Calls, Missed Calls, Received Calls and Dialed Calls.

A.2.4 Configuring the 'Forward No Reply' Timeout as Number of Rings

The 'Forward No Reply' timeout can be configured as 'number of rings' rather than as 'seconds'. Consult with your network administrator to enable this feature (see the *Administrator's Manual* for details). For example, the phone can be configured to ring 2r (2 rings), or 4r (4 rings), for example, before calls are forwarded. The setting can be changed according to user preference.

A.2.5 Automatically Receiving an External Line

The phone by default features *automatic switching*. Users do not need to press the 9 key, for example, in order to receive an external line; they can directly dial the number of the party they want. To configure *manual switching*, consult the network administrator (see the *Administrator's Manual*). When configured, users must press the 9 key, for example, to get a line to outside the enterprise; after pressing the key, they hear a secondary tone. They only then can dial the number of the party they need.

A.2.6 Limiting Configuration of Function Keys as Line Keys

Users cannot configure all Function Keys as Line Keys.

A.2.7 Viewing VOICEMAIL Indications *Per Line*



Applies to all environments (not only to BroadSoft).

When a phone is in a Multi Line configuration, VOICEMAIL is indicated *per line*.

A.2.8 Listening in Capability for Call Center Supervisors

Call center supervisors can pick up an operator's phone and listen in on the conversation that the operator is conducting on headphones with the customer, without the customer at the other end sensing that the supervisor is listening in (because the supervisor is in effect muted).

A.2.9 Recording an Agent's Welcome Greeting

Agents in a call center can record personal voice greetings which play automatically when calls come in. An agent's recorded voice greeting welcomes callers to the service they're seeking. For example: **Thanks for contacting Julie at Southern California Edison, how can I assist you?**



Before using this feature, your network administrator must enable it. For more information, see the *Administrator's Manual*.

The feature

- Allows agents to record greetings directly on the phones
- Replaces cumbersome management from a media server
- Replaces ad-libbed amateurish greetings
- Gives callers a good first impression of the call center
- Professionalizes customer care
- Improves agent productivity
- Makes customers feel welcome when they consistently hear a cheerful and polite greeting.

To record a welcome greeting:

1. Open the Greeting Message screen (**MENU** key > **Settings** > **Greeting Message**).



While the Greeting menu is open no calls can come in.

2. Press the recording softkey and record your welcome greeting (max length: 10 seconds)
3. When you finish recording, press the stop softkey.
4. Press the play softkey to play back your recording.
5. Press the **Save** softkey to save the recording. To delete the message select the **Delete** softkey.

A.3 Genesys' Contact Centers

This section shows how to use AudioCodes IP phones in Genesys contact centers.



The section is intended mainly for agents / hotline operators.

A.3.1 Using the BroadSoft ACD

Genesys Contact Center phones support the BroadSoft ACD. The table below shows how to use the functionalities.

Table A-2: Genesys Contact Center Phones' BroadSoft ACD

State		Softkeys Displayed	Command Menu Options
Idle	Ready	-	<ul style="list-style-type: none"> ■ Missed Calls ■ Forward ■ DnD
	Not Ready	-	<ul style="list-style-type: none"> ■ Missed Calls ■ Forward ■ DnD
Idle	ACW	-	<ul style="list-style-type: none"> ■ Missed Calls ■ Forward ■ DnD

A.3.1.1 Setting Unavailability Status

In the course of a shift, you may need to leave your desk for a break or to attend to other issues. Before leaving your desk, change your status to 'Not Ready' (unavailable) so that incoming calls to the Contact Center will not be sent to you.

To change your status to 'Not Ready':

1. In the idle screen, press the **Not Ready** softkey and select the reason for not being ready to take a call. For example, you'll be at lunch or on a coffee break; the 'Ready' indication changes to 'Not Ready':
2. If you have just finished a session with a customer and wish to carry out administrative tasks related to the call, then press the ACW (After Call Work). The 'After Call' status is displayed on the phone's LCD.

A.3.1.2 Setting Availability Status

When you return to your desk after taking a break or after attending to an external issue, it's important to restore your status to 'Ready' and resume work.

To restore your status to 'Ready':

- In the idle screen, press the **Ready** softkey; the 'Not Ready' indication changes to 'Ready'.

A.3.2 Presence Management

This section describes how to login to and logout from the Call Center SIP server and to update your presence status when the ACD (Automatic Call Distribution) feature is enabled.



When the ACD feature is enabled, whenever you login or logout or change your presence status, these updates are sent to the Call Center SIP server. This server then can automatically distribute incoming calls to different agents' phones based on their relative availability. For more information, see the *Administrator's Manual*.

A.3.3 Logging In

This section shows you how to log in to the Genesys Call Center SIP server. Log in immediately after starting a shift.

To log in to the phone:

1. When the phone's LCD is in idle mode (Logged Out), press the **Login** softkey; the Log In screen is displayed.
2. Enter your Username. Obtain it from your system administrator. Press the **A/a/1** softkey successively to navigate to and select the alphanumerical mode you require (**abc**, **ABC**, or **Abc**).
3. Scroll down and enter your Password.
4. Press the **Login** softkey; the Ready idle screen is displayed.

You're now available to take incoming calls. Incoming calls from now on will be directed to your phone.

A.3.4 Logging Out

At the end of your shift, log out of the phone.

To log out of the phone:

- In the idle screen, press the **Logout** softkey; the Logged Out indication is displayed:

A.3.5 Configuring Do Not Disturb (DnD)

You can configure the phone so that no incoming calls will disturb you.

To configure DnD:

1. From the idle screen, open the Command Menu.
2. Scroll down and select the **DnD** option.
3. In the idle screen to which you're returned, view the DnD indication.

A.3.6 Configuring Automatic Forwarding

When you leave your workstation you can configure the phone so that any incoming calls will be forwarded.

To configure automatic forwarding:

1. In the idle screen, press the **≡** softkey; the Command Menu opens.
2. Select the **Forward** option; the Automatic Forward screen opens.

3. Select the **Always** option or scroll down and select the **Busy** or **No Reply** option.
4. Enter the **Number to Forward** to, or scroll down and select **Select from Directory** in which you can choose a contact number to which to forward calls.
5. In the idle screen to which you're returned, view the 'Forward' indication.

A.3.7 Listening in Capability for Call Center Supervisors

Call center supervisors can pick up an operator's phone and listen in on the conversation that the operator is conducting on headphones with the customer, without the customer at the other end sensing that the supervisor is listening in (because the supervisor is in effect muted).

A.3.8 Setting up a Remote Conference

This section shows how to set up a remote conference to which *more than* three participants can be added. A 'local' conference only supports *a maximum of three* participants.



Only after the enterprise's network administrator enables the feature, you can establish a remote conference.

To establish a remote conference | add participants:

1. From the idle screen, call participant 1 either from a directory or from a call log.
2. Participant 1 answers and the call is established.
3. Press the **Conf** softkey.
4. Add participant 2: Press the **Add** softkey, enter their number and press the **Dial** softkey.
5. Add participant 3 in the same way.



After adding the first participant by selecting the **Conf** softkey, the letter **C** is displayed in the phone screen indicating that this is a conference call.

Note also that the names of all participants participating in the conference are typically displayed here. Names will scroll horizontally if they are longer than the box.

International Headquarters

1 Hayarden Street,
Airport City
Lod 7019900, Israel
Tel: +972-3-976-4000
Fax: +972-3-976-4040

AudioCodes Inc.

200 Cottontail Lane
Suite A101E
Somerset, NJ 08873
Tel: +1-732-469-0880
Fax: +1-732-469-2298

Contact us: <https://www.audiocodes.com/corporate/offices-worldwide>

Website: <https://www.audiocodes.com/>

©2021 AudioCodes Ltd. All rights reserved. AudioCodes, AC, HD VoIP, HD VoIP Sounds Better, IPmedia, Mediant, MediaPack, What's Inside Matters, OSN, SmartTAP, User Management Pack, VMAS, VoIPerfect, VoIPerfectHD, Your Gateway To VoIP, 3GX, VocaNom, AudioCodes One Voice, AudioCodes Meeting Insights, AudioCodes Room Experience and CloudBond are trademarks or registered trademarks of AudioCodes Limited. All other products or trademarks are property of their respective owners. Product specifications are subject to change without notice.

Document #: LTRT-14852

